**Sarimay-Dzhankeldy
Transmission**

**Environmental & Social
Impact Assessment (ESIA):
Volume VI - Land Acquisition
and Livelihood Restoration
Framework**

CLIENT: NEGU

Date: March 2022



Juru Energy Ltd.

Suite 1, One George Yard, London

United Kingdom, EC3V 9DF

T: +44 207 859 4028

Document Information

| | |
|--|---|
| Project Name | Sarimay-Dzhankeldy Transmission |
| Document Title | Land Acquisition and Livelihood Restoration Framework |
| Juru Energy's Project Reference | UZB _Sarimay-Dzhankeldy |
| Client | NEGU |
| JE Project Manager | Nicola Davies |
| JE Project Director | Jushkinbek Ismailov |

Document Control

| Version | Version Date | Description | Author | Reviewer | Approver |
|---------|--------------|--|--------------------------------------|-----------------|---------------|
| 1.0 | 10/01/2022 | Land Acquisition and Livelihood Restoration Framework | Zilola Kazakova Umida Rozumbetova | Marianne Lupton | Nicola Davies |
| 2.0 | 25/02/2022 | Final Draft Land Acquisition and Livelihood Restoration Framework for review | Zilola Kazakova Umida Rozumbetova | Marianne Lupton | Nicola Davies |
| 3.0 | 18/03/2022 | Final Land Acquisition and Livelihood Restoration Framework for disclosure | Zilola Kazakova Umida Rozumbetova | Marianne Lupton | Nicola Davies |

Disclaimer:

The Land Acquisition and Livelihood Restoration Framework ("LARF") has been prepared by Juru Energy. Whilst the information contained in the LARF is reflective of the current status, Juru Energy make no representation or warranty, express or implied, as to the accuracy of the information set forth in this LARF, and accept no liability for any information that may have been misstated or omitted. LARF has been prepared exclusively for NEGU. NEGU makes no representation or warranty, express or implied, as to the accuracy or completeness of the information set forth in this document. NEGU has not independently verified any of the information contained in this LARF and accept no liability whatsoever for any information, misstatement or omission contained therein. LARF remains NEGU 's property.

Contents

| | |
|--|-----|
| Table of figures | iii |
| Table of tables | iii |
| 1 Introduction | 1 |
| 1.1 Overview and Project background | 1 |
| 2 Project description | 2 |
| 2.1 Project components | 5 |
| 3 Project impacts | 6 |
| 4 Legal framework | 10 |
| 4.1 National regulations | 10 |
| 4.2 EBRD Performance Requirements | 14 |
| 4.3 Gap analysis between EBRD Performance Requirements 5 and 10 and national regulations | 15 |
| 5 Affected people and assets | 18 |
| 5.1 State Committee on Sericulture and Wool Industry Development | 20 |
| 5.2 Lot 1 | 22 |
| 5.3 Lot 2 | 26 |
| 5.4 Scope of economic displacement | 28 |
| 6 Key compensation and assistance principles | 29 |
| 6.1 Land acquisition process | 29 |
| 6.2 Servitude process | 31 |
| 6.3 Implementation process | 33 |
| 7 Eligibility | 42 |
| 8 Entitlement matrix | 43 |
| 9 Compensation and assistance | 50 |
| 9.1 Compensation for land acquisition | 50 |
| 9.2 Methods of valuing affected assets | 52 |
| 9.3 Crops and trees | 52 |
| 9.4 Incomes | 52 |
| 9.5 Compensation for servitude | 53 |
| 9.6 Vulnerable groups | 53 |
| 9.7 Allowances | 53 |
| 10 Implementation schedule | 54 |
| 11 Livelihood restoration activities | 54 |
| 12 Organizational arrangements | 54 |
| 12.1 Key responsible parties | 55 |
| 13 Time frame | 56 |
| 14 Disclosure of information and consultations | 57 |
| 14.1 Consultations | 57 |
| 14.2 Stakeholders | 57 |
| 14.3 Future engagement with PAPs | 58 |
| 15 Grievance mechanism | 58 |

| | | |
|------|---|----|
| 15.1 | Grievance reporting and resolution..... | 58 |
| 15.2 | Responsibilities..... | 58 |
| 15.3 | Contact details..... | 59 |
| 15.4 | Confidentiality and anonymity..... | 59 |
| 15.5 | Grievance resolution options and response..... | 59 |
| 16 | Monitoring and reporting..... | 61 |
| 16.1 | Resettlement reporting..... | 62 |
| 16.2 | Resettlement completion report..... | 62 |
| 16.3 | Grievance logging..... | 62 |
| 17 | Implementation costs..... | 62 |
| | Annex A: Resettlement Plan Table of Contents..... | 63 |
| | Annex B: Project grievance form..... | 66 |
| | Annex C: Project grievance log..... | 68 |

Table of figures

| | | |
|------------|---|----|
| Figure 1: | Project Location of Sarimay-Dzhankeldy OHTL (Lot 1)..... | 3 |
| Figure 2: | Project Location 500KV Navoi TPP - Bash SS - Murantau SS LILO OHTL Connection..... | 4 |
| Figure 3: | Simplified schematic of the proposed Project at wider 500kV transmission network..... | 6 |
| Figure 4: | Herder settlement..... | 7 |
| Figure 5: | Water pump boreholes for livestock..... | 7 |
| Figure 6: | Location of herders' settlements in relation to Lot 1..... | 8 |
| Figure 7: | Location of herders' settlements in relation to Lot 2..... | 9 |
| Figure 8: | Organisational structure of Committee..... | 22 |
| Figure 9: | Preliminary grazing area of Herder 1..... | 24 |
| Figure 10: | Preliminary grazing area of Herder 2..... | 25 |
| Figure 11: | Preliminary grazing area of Herder 3..... | 26 |
| Figure 12: | Preliminary grazing area of Herder 4..... | 27 |
| Figure 13: | The scheme for calculating losses of owners, users, leaseholders and proprietors of land plots, as well as losses of agricultural and forestry production (where applicable)..... | 40 |
| Figure 14: | The scheme for servitude..... | 41 |
| Figure 15: | Grievance mechanism flow chart..... | 61 |

Table of tables

| | | |
|-----------|--|----|
| Table 1: | Summary of other relevant legislation..... | 12 |
| Table 2: | Main gaps between national legislation and EBRD PR5 and PR 10..... | 15 |
| Table 3: | Land required for the Project..... | 19 |
| Table 4: | Estimated number of displaced persons..... | 20 |
| Table 5: | Distance of herders' settlements in relation to OHTLs (Lot 1)..... | 23 |
| Table 6: | Distance of herders' settlements in relation to OHTLs (Lot 2)..... | 27 |
| Table 7: | Implementation process..... | 33 |
| Table 8: | Eligibility for compensation for PAPs..... | 42 |
| Table 9: | Entitlement matrix..... | 44 |
| Table 10: | Current anticipated development schedule (February 2022)..... | 56 |
| Table 11: | Contact details:..... | 59 |
| Table 12: | NEGU Contact details..... | 59 |
| Table 13: | Grievance Process and Timeline..... | 60 |

List of Abbreviations

| Acronym | Definition |
|----------------|---|
| CoM | Cabinet of Ministries |
| CC | Civil Code |
| EBRD | European Bank for Reconstruction and Development |
| ESIA | Environmental and Social Impact Assessment |
| ESP | Environmental and Social Policy |
| GoU | Government of Uzbekistan |
| GRM | Grievance Redress Mechanism |
| IFI | International Financial Institutions |
| JE | Juru Energy Ltd |
| LARF | Land Acquisition and Livelihood Restoration Framework |
| LC | Land Code |
| LILO | Line-in Line out |
| LRP | Livelihood Restoration Plan |
| LLC | Limited Liability Company |
| MoM | Minutes of Meeting |
| NEGU | National Electric Grids of Uzbekistan |
| OHTL | Overhead Transmission Line |
| PAP | Project Affected Person |
| PR | Performance Requirement |
| RAP | Resettlement Action Plan |
| RoW | Right of Way |
| S-D | Sarimay - Dzhankeldy |
| SS | Substation |
| SwS | Switching Station |

1 Introduction

1.1 Overview and Project background

The European Bank for Reconstruction and Development (the “EBRD” or the “Bank”) is considering providing loan to finance the construction of a 500 kV overhead transmission line (OHTL) in Uzbekistan between the existing Sarimay substation (SS) (Khorezm region) and the planned Dzhankeldy SS (Bukhara region) (Lot 1) (see Figure 2); and a related 10 km 500 kV line-in line out (LILO) OHTL (Lot 2) from the Bash switching station (SwS) (under development) to the 220 kV/500 kV Muruntau-Navoi OHTL (currently under construction)^{1,2}. Together Lot 1 and Lot 2 are referred to as the “Project”.

The Project's main purpose is to facilitate the evacuation to the national power grid of the electricity generated by renewable energy power plants under development in the Bukhara and Navoi region. Implementation of the Project will also significantly improve the transmission network's reliability, efficiency, stability, and quality and security of the electricity supply.

NEGU will be responsible for construction and implementation of the Project. EBRD has appointed Juru Energy Ltd. (JE) as the Environmental and Social Impact Assessment (ESIA) Consultant for the Project following EBRD Environmental and Social Policy 2019 (ESP 2019) and supporting Performance Requirements (PRs), and specifically PR5: Land Acquisition, Restrictions on Land Use and Involuntary Resettlement.

This Land Acquisition and Livelihood Restoration Framework (“LARF”) has been prepared on behalf of NEGU to guide and implement resettlement planning. The aim of this LARF is to identify resettlement principles and organizational arrangements and to provide a guide to the provision of livelihood restoration, should any impacts be identified in the future.

At the time of writing this LARF the Project final design and development schedule are still being finalised. However, based on preliminary design no structures or assets are expected to be impacted by the Project.

A Livelihood Restoration Plan (LRP) will need to be prepared based on this LARF once the final design has been completed³. JE is currently undertaking the ESIA study. Initial categorizations have been identified under EBRD and Uzbek law. The Project is considered a Category I (high risk) under the national legislation (see Chapter 4.1) and Category A under EBRD requirements (see Chapter 4.2).

This LARF is organised by chapters that cover:

¹ The 220kV/500kV Navoi to Muruntau-Navoi TPP OHTL is currently in the early stages of construction and is also being financed by EBRD.

² The Muruntau-Navoi 500 kV OHLT, Bash SwS, and Muruntau SS are already under development and are considered associated activities. The Dzhankeldy wind farm (WF) (developed by private third party) and the Bash WF (developed by private third party) that will be connected to the Bash SwS and Dzhankeldy SS respectively are not solely dependent on the Project, nor do they directly or indirectly influence the project. As such there are not associated activities or facilities as defined by EBRD PR1 para 9.

³ The requirement to prepare a LRP and discharge obligations prior to site mobilisation has been included in the Project Environmental and Social Action Plan (ESAP) which will form a condition of the financing process.

- Project description;
- Project impacts;
- Summary of Uzbek and EBRD requirements for involuntary resettlement;
- Identification of affected people and assets;
- The principles of compensation and assistance;
- The eligibility criteria;
- An entitlement matrix;
- Types of compensation and assistance available;
- Responsibilities for and implementation of involuntary resettlement;
- Implementation timeframes;
- Types of disclosure activities;
- Project grievance mechanism;
- Monitoring and reporting; and
- Implementation costs and a preliminary budget.

2 Project description

Lot 1 passes through an unmodified area of Kyzilkum district. This route currently crosses Turtkul district of the Republic of Karakalpakstan ⁴, Toproqqala district of Khorezm region and Peshku district of Bukhara region (Figure 1). The Lot 1 section of the OHTL runs from the existing Sarimay SS, which is located in Toproqqala district and the planned Dzhankeldy SS located in Peshku district.

⁴ DRAFTING NOTE: According to the ministry of makhalla of Karakalpakstan the boundaries of the provinces have been changed and the OHTL does not cross Karakalpakstan with the territory now part of Khorezm province. At this time updated maps have not yet been issued, and according to the current available border maps, the OHTL still traverses through Karakalpakstan

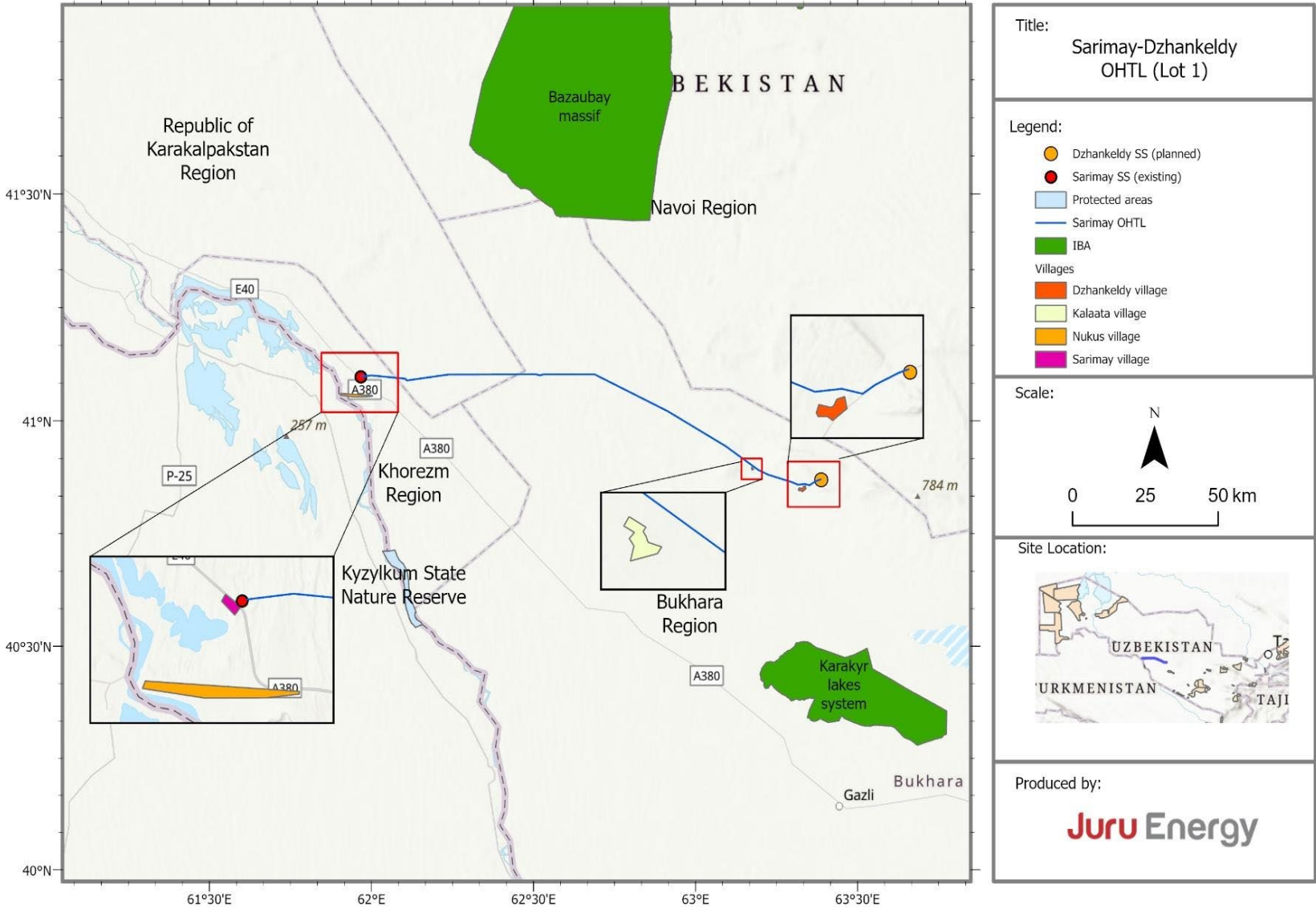

Figure 1: Project Location of Sarimay-Dzhankeldy OHTL (Lot 1)

Lot 2 located in Gijduvan district of Bukhara region (Figure 2).

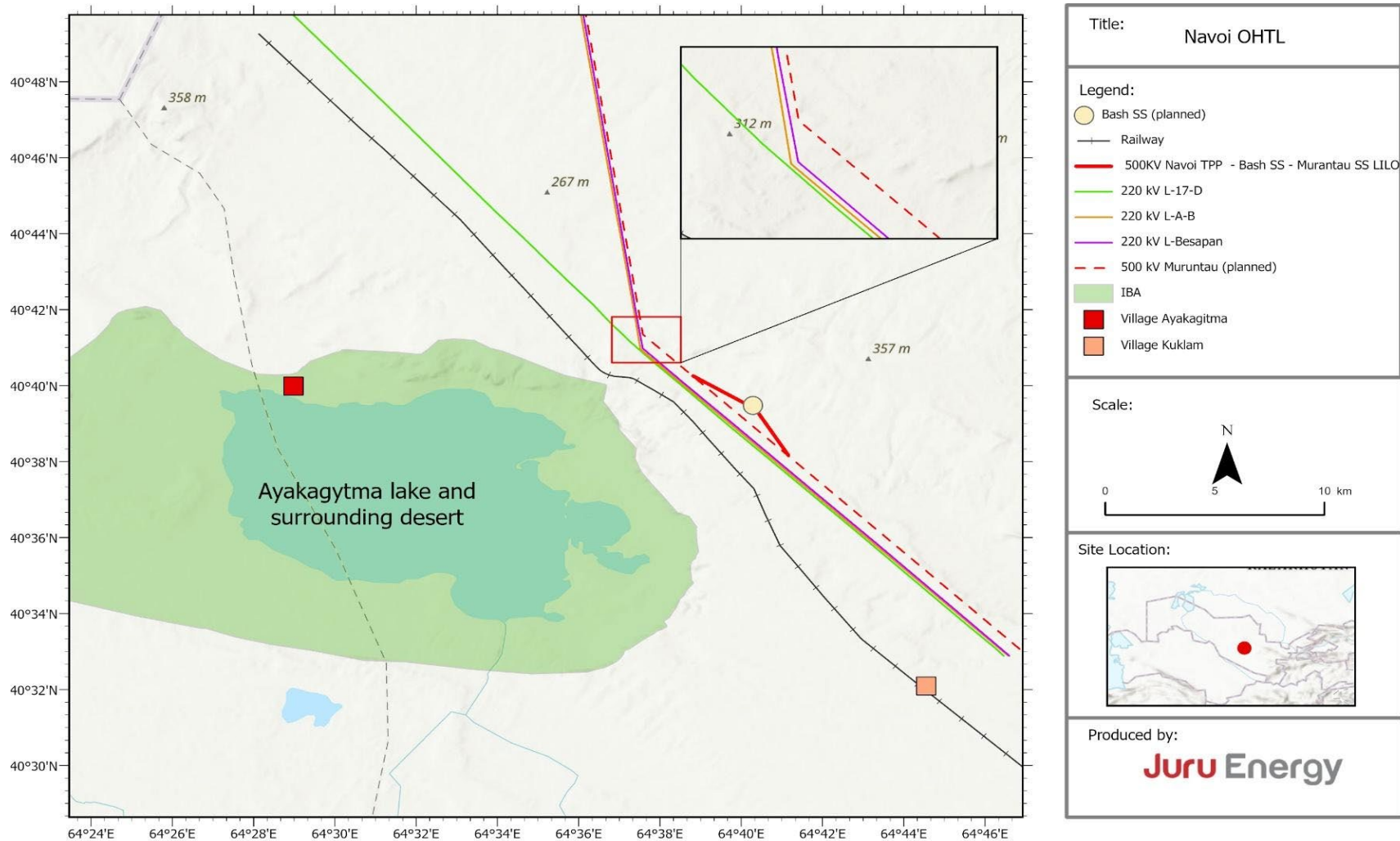

Figure 2: Project Location 500KV Navoi TPP - Bash SS - Murantau SS LILO OHTL Connection

2.1 Project components

The primary components of the Project are:

- Lot 1 - 500 kV Sarimay- Dzhankeldy OHTL (S-D OHTL) - approximately 127 km OHTL located in the southwestern part of the Kyzyl-Kum Desert.
- Lot 2 – 500 kV Navoi TPP – Bash SS - Muruntau SS LILO OHTL (N-B-M LILO) - approximately 10 km in length, split between two 5 km sections for a LILO connection from the 500kV Bash SS (under development) to the 500 kV Muruntau-Navoi OHTL (under construction).

The main components of an OHTL are the towers, foundations, and conductors.

- Towers are typically either suspension, angle or terminal towers that can either be self-supporting or guyed towers with a tower height of approximately 30 to 40 m.
- Foundations are required to fix the towers in place, the foundations may be up to two meters deep, depending on geotechnical requirements.
- Conductors are the lines that string between each tower that transmit the electricity. The distance between each tower is the span; typical spans are between 300 m and 400 m.

Related works in support of the OHTL works will include:

- End-user works at the existing Sarimay SS
- End-user works at the planned Dzhankeldy SS
- End-user works at the planned Bash SwS
- Establish 60m right of way ROW under the OHTL (including provision of any related livelihood compensation) (Lot 1 and Lot 2)
- Upgrade existing road or new road (unsurfaced) suitable to provide access to the OHTL tower worksites (Lot 1 and Lot 2)

ROW⁵ size is dictated by Uzbekistan standards and for a 500 kV project it is 30 m on either side of the OHTL outermost conductor).

The Sarimay SS is already in operation under the control of JSC NEGU. No expansion to the Sarimay SS is expected. Private third parties will construct the Dzhankeldy SS and Bash SwS. An ESIA for the construction, operation and decommissioning of these assets is under development and is being developed according to IFC Performance Standards 2012. It is expected that these new substations will be sized to accommodate the works required for the S-D OHTL (Lot 1 and Lot 2) works.

The Muruntau SS and the 500kV Navoi to Muruntau/Besopan OHTL are considered associated facilities to the Project and have already been subject to ESIA following EBRD ESP 2019 by third party entities.

⁵ The right of way (ROW) is termed the Sanitary Health Protection Zone (HPZ) in Uzbekistan and may also be referred as servitude.

A simplified line diagram illustrating the proposed Project Lots and their connection to the region's immediate transmission network is provided in figure below.⁶

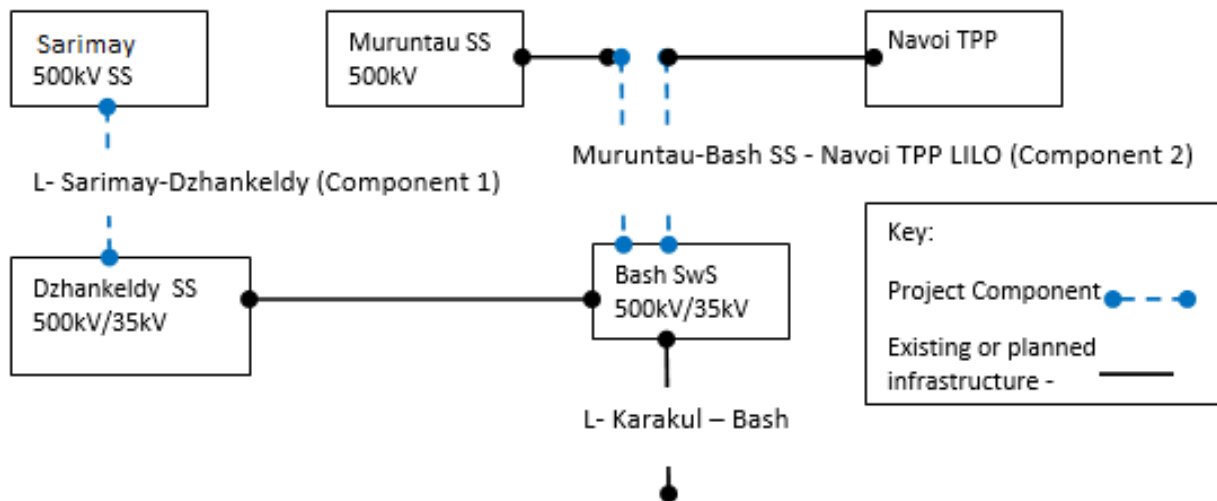

Figure 3: Simplified schematic of the proposed Project at wider 500kV transmission network

3 Project impacts

Projects involuntary resettlement impacts will be in the form of land acquisition for the tower footprints, servitude for the right of way (ROW) under the OHTL, temporary land use for laydown areas, worker accommodation and access roads and for any impacts to livelihoods of those people using the land. It is not expected that any structures, crops or trees will be impacted, therefore no physical displacement of households will be required.

The proposed ROW for Lot 1 (from Sarimay to Dzhankeldy) and Lot 2 (Bash) cross the Kyzylkum desert. These lands have been allocated to the State Committee of Sericulture and Wool Industry Development (the Committee) by the Government of Uzbekistan. The Committee allocates sections of land to limited liability companies (LLCs) to manage the land. The land included in Lot 1 is managed by Dzhankeldy LLC and the land for Lot 2 is managed by Kokcha LLC. These LLCs employ herders to graze animals on the land.

Site observations indicated that in the vicinity of the ROW for Lot 1 there are three herders who use land for grazing LLC owned and personal livestock. Since herders are involved in grazing activities all year round, they have constructed their own herding settlements⁷ that contain permanent and temporary structures. One herder employs two workers, the remainder of the herders use family members to assist them. Figure 4 provides a photograph of a herder settlement and Figure 5 is a photograph of water pump boreholes that are used by herders for their livestock.

⁶ Other lines in the vicinity of the Bash SS are i) 220 kV line between Navoi TPP - Bessapan SP (Switching Point), ii) - 220 kV line between Substation "A" - Bessapan SP, dispatching name of the line - "L-A-B ", iii) - 220 kV line between Navoi TPP - Substation "D", dispatching name of the line - "L-17-D" (refer to Figure 3).

⁷ The herder settlements are not the permanent residences of these herders, these are located in other districts of Bukhara.



Figure 4: Herder settlement



Figure 5: Water pump boreholes for livestock

All permanent structures are outside the currently proposed 60m ROW. Therefore, the proposed alignment of the ROW for Lot 1 is not going to affect the assets of herders, only land where they graze livestock. The locations of the potentially affected herders for Lot 1 are illustrated in Figure 6 below:

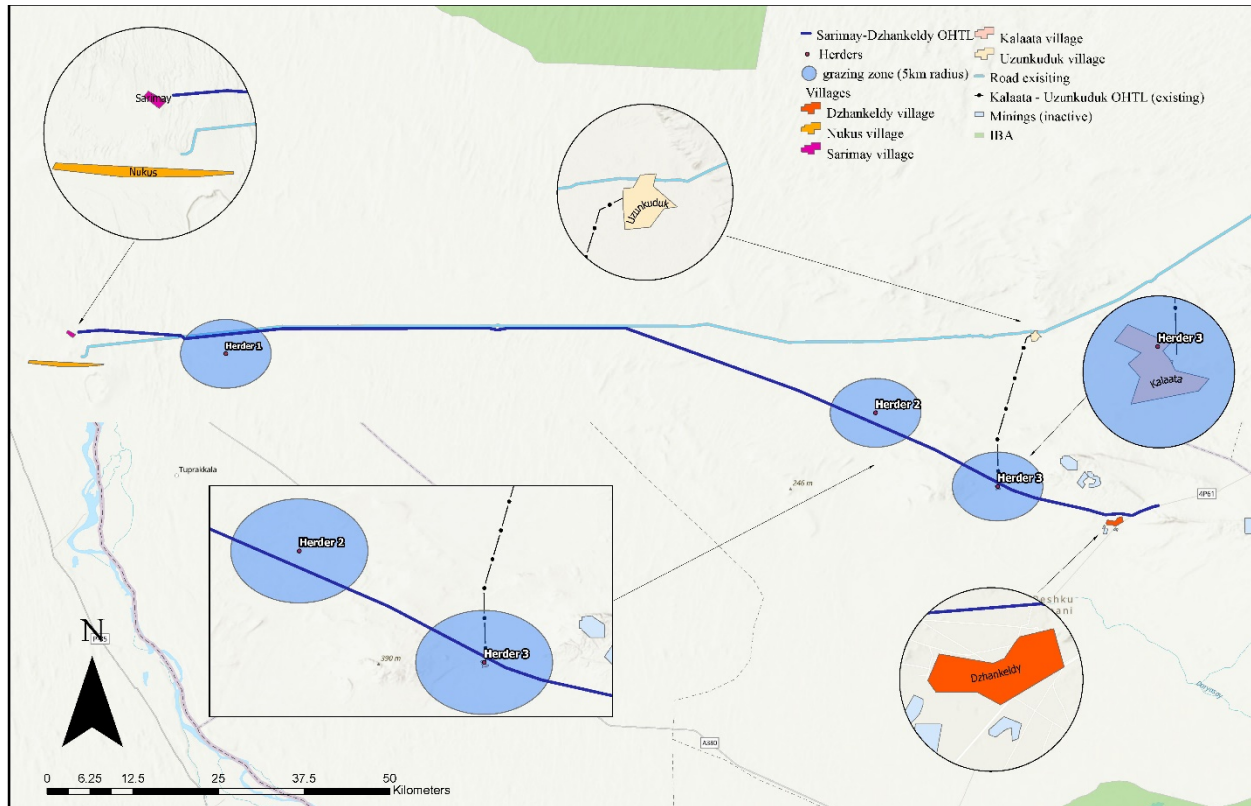

Figure 6: Location of herders' settlements in relation to Lot 1

At Lot 2 there are two herder settlements belonging to one herder located close to the Lot 2 ROW. The herder employs two workers and occasionally enlists his family to assist herding LLC owned and personal livestock. Similar to Lot 1, all permanent structures and the herders' assets are outside the currently proposed 60m ROW and are not going to be impacted by the establishment of the OHTL ROW. However, herder's might be affected in terms of land availability, i.e., the Project works might impact the herder's grazing areas which are approximately within a radius of 5 km from each herder settlement.

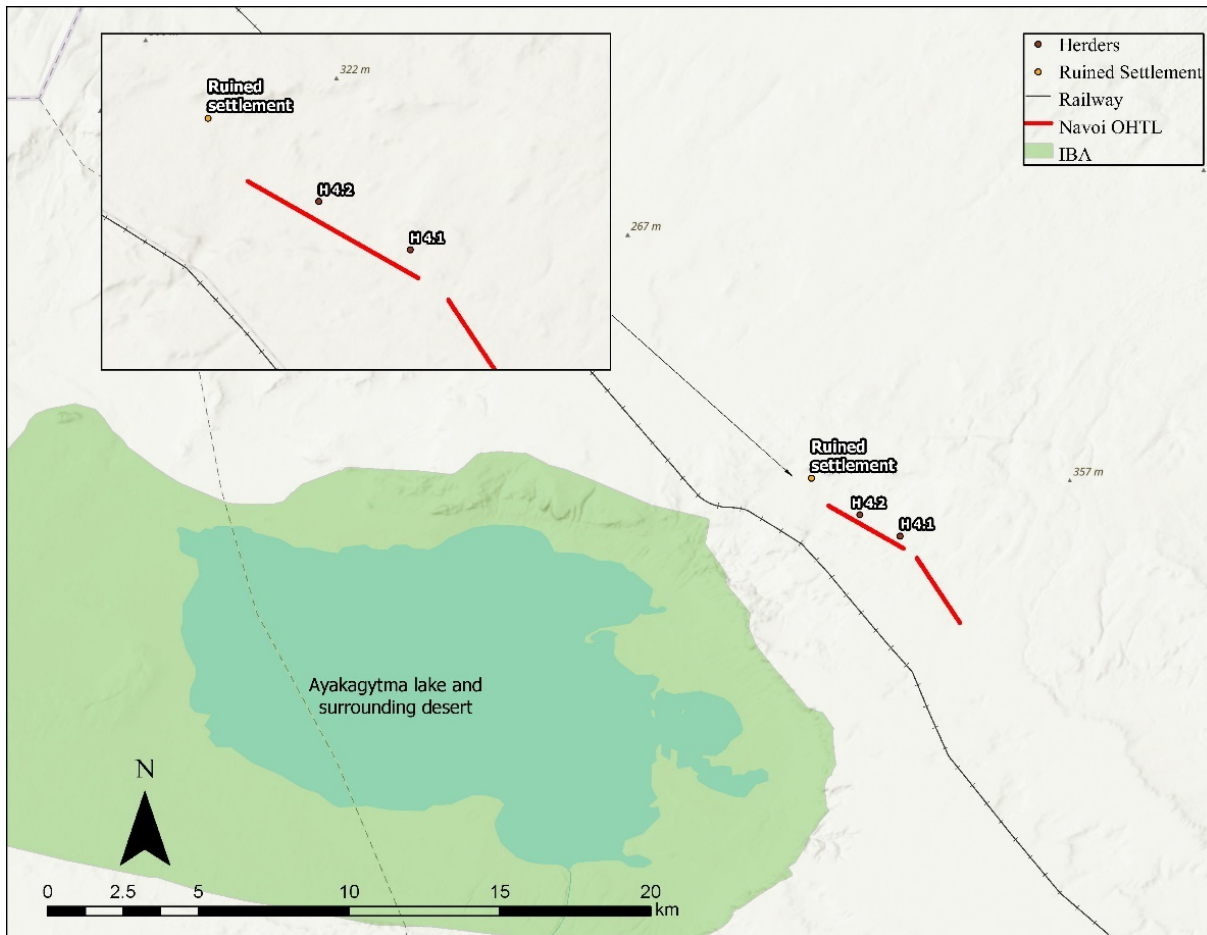

Figure 7: Location of herders' settlements in relation to Lot 2

Further details on the affected people and assets are discussed in section 5. PLEASE NOTE: The Lot 2 ROW is located inside the Area of Impact (AOI)⁸ of the Bash 500 MW wind farm which will be constructed by ACWA Power. All herders that live within the Bash 500 MW wind farm AOI, including Herder 4 (H4), will be resettled as a result of the wind farm construction⁹. If the construction of the Bash 500 MW wind farm starts earlier than construction of the S-D OHTL then there will be no affected herders along Lot 2.

⁸ For details of the Project AOI, please see the Project ESIA.

⁹ This resettlement relates to their herder settlements, not their permanent residents which are located in other districts of Bukhara.

4 Legal framework

The Project will need to comply with the legal requirements of Uzbekistan as well as the EBRD Performance Requirements, in regards to land acquisition and involuntary resettlement. These requirements are summarized in the following sections.

4.1 National regulations

Land acquisition is regulated by various legal acts in Uzbekistan. Construction of OHTLs requires obtaining permanent land acquisition as well as the servitude (user rights) for both the land under the OHTL and the necessary ROW. The following text provides a summary of the legal acts that regulate land acquisition and rights of way in Uzbekistan.

4.1.1 Constitution of the Republic of Uzbekistan (1992)

The Constitution of the Republic of Uzbekistan (dated December 8, 1992) provides that every citizen of the country has a right to own property (Article 36).

Article 53 of the Constitution states that the GoU guarantees protection of ownership and provides freedom for owners/leaseholders to undertake activities that are conducted on the owned land, i.e., economic activities, entrepreneurship and labour with due regard to the priority of consumers' rights.

Landowners/land leaseholders have the right to use and dispose of land as they wish (except in the case of activities that may harm the environment or local communities) (Article 54).

4.1.2 Land Code (1998, as amended in 2019)

The Land Code (LC) covers all land issues, including land acquisition, land allocation, transfer and sales of land plots, and determines types of land ownership.

Article 16 of the LC defines that the State is the owner of all land in the country and also the main responsible body for its use.

Article 36, Clause 1: defines that termination of the right of permanent and temporary land use is made following the decisions of local administration representatives, i.e., Khokims (mayors) of administrative divisions (district/city/region). If landowners do not agree with the decisions of khokims they have the right to appeal to the court (Article 36, Clause 4).

Article 37, Clause 1: acquisition of land or part of it for State or public needs shall be carried out with the consent of the landowner and/or leaseholder under the decision of the district, city, region or under the decision of the Cabinet of Ministers of the Republic of Uzbekistan.

Article 37, Clause 2: states that in the case of a disagreement by the landowner and/or land leaseholder with the decision of the acquisition of the land plot, this decision may be appealed in the court.

Article 39 Clause 1: in the case of land acquisition, the landowner, land leaseholder and house owners have the right to be refunded for their losses (including lost profit) or compensation costs for voluntary renunciation of land.

Article 41, Clause 3: losses caused by violation of the rights of land lease, tenants and landowners (including lost profits), shall be reimbursed in full.

Article 41, Clause 4: an equivalent land plot and compensation of losses including lost profits may be provided to a land user or tenant due to acquisition of the land to the State or for public need.

Article 86, Clause 1: specifies the cases where losses to land users must be compensated in full including loss of profits:

- Acquisition, redemption or temporary occupation of land.
- Limitation of their rights due to the establishment of water protection zones, coastal strips, sanitary protection zones of water bodies, zones of formation of surface and underground water, zones of resort areas, biosphere areas, protection zones around national parks, reserves, national nature monuments, cultural heritage objects, discharges, roads, pipelines, communication and power lines.
- Worsening of the quality of land as a result of the affect caused by construction and exploitation of water reservoirs, canals, collectors and other objects exuding harmful substances for agricultural crops and plantations and other actions of juridical and real persons causing the decrease of harvests or worsening of the quality of agricultural goods.

Article 87, Clause 1: losses of agricultural and forestry production caused by the acquisition of agricultural and forest land, including agricultural land owned and used by individuals for purposes not related to agriculture and forestry, restrictions on the rights of land leaseholders, or deterioration of land due to impacts caused by the activity of enterprises, institutions and organizations shall be compensated in addition to the compensation stipulated.

4.1.3 Civil Code (1990, as amended in 2019)

The Civil Code (CC) protects legal Uzbek citizens in relation to ownership of all types of property (material, intellectual etc). The CC determines the main provisions/general rules for valuation of property, cases of confiscation of property, and rights for compensation. In particular, the CC establishes that in cases of violation of right of the citizen of Uzbekistan, all loses should be fully compensated, unless the law or the contract does not provide compensation for losses (Article 14).

Article 83 defines land plots, subsoils, building/structures, perinatal plants as immovable property (real estate). Immovable property includes plots of land, subsoil, buildings, constructions, perennial plants and other property firmly connected with the land i.e. objects whose displacement without disproportionate damage to their purpose is impossible.

The CC also defines that all real estate property should be legally registered (Article 84). As a result, all property without registration is not required to be compensated.

4.1.4 Resolution of Cabinet Ministers No. 146 (May 25, 2011)

Resolution of Cabinet Ministers No. 146 “On measures to improve the procedures for granting land plots for urban development activities and other non-agricultural purposes” is aimed to improve the procedure for allocation of land in Uzbekistan to physical and legal entities and encourage efficient use of land.

Annex 2 of the current Resolution defines the calculation of compensation for types of properties, mainly for agricultural and forestry loses. Compensation costs should be provided by the new owner of the land (physical/legal entities) to whom the land was allocated.

Compensation for all loses should be provided in the following cases:

- Permanent and temporary occupation of land;
- Limitation of rights for an owned/leased land plot (e.g., establishing buffer, protection, sanitary health protection zones);
- Damages to assets or degradation of quality of land caused by the construction and exploitation of water reservoirs, canals, collectors and other facilities that emit substances harmful to crops and plantations, and other actions of legal entities and individuals that lead to a decrease in crop yields and deteriorating quality of agricultural products (Article 5 of Annex 2).

In the case of land acquisition, redemption or temporary occupation of land plots or a part thereof shall be compensated:

- The cost of the land plot privately owned by legal entities and individuals;
- The cost of residential houses, structures and facilities, including facilities that have not been completed, as well as those outside the allotted land plot, if their further use is impossible due to the acquisition of land;
- The cost of fruits and vegetables, productive and other perennial plantations;
- The cost of unfinished agricultural production; and
- Loss of profit.

According to this Resolution, land can be acquired from the current owner and resettlement can take place only after provision of compensation. In the case that ownership cannot be not proven for land or assets, then loses are not subject to compensation.

4.1.5 Other relevant Presidential Decrees and Resolutions of Cabinet of Ministers

Additional national laws and legislations related to land acquisition and compensation in Uzbekistan are provided in Table 1 below.

Table 1: Summary of other relevant legislation

| Legal Requirement | Summary |
|--|---|
| Presidential Decree “On measures to improve the effectiveness of training and realizing projects with participation of international financial institutions and foreign government financial organizations” dated July 16, 2018 No. 3857 | Determines the regulations and rules for projects that are carried out with participation of International Financial Institutions or banks. In the case of differences between the resettlement policies in the Uzbek legal framework and the International Financial Institutions (IFI), the policies of the IFI’s will be followed by Executing Agencies and resettlement costs (compensation in the case of acquisition of land plots, demolition of houses and other structures, crops or trees) paid based on assessment documents prepared by IFI using their methodology. |
| Presidential Decree “On measures for major improvement of the investment climate in the Republic of Uzbekistan” dated August 1, 2018 No. 5495 | This resolution defines that in cases of land allocation for investment projects other international policies are also applicable. Moreover, it clearly states that calculation of compensation should be done considering market prices. |

| Legal Requirement | Summary |
|---|---|
| Resolution of the Cabinet of Ministers No 911 from November 16, 2019 “On further improving procedures for providing property rights of individuals and legal entities and procedures for removal and compensation for land plots” | Current legislation provides the following: <ul style="list-style-type: none"> - Procedures and timing for land acquisition; - Regulations and timing for providing compensation for losses/damages occurred as a result of land acquisition; and - Responsible parties and states organisations for ensuring payment of compensation and allocating land to the new owner |
| Tax Code of Uzbekistan | The Tax Code assumes that when compensation is received in a monetary form, the payment of taxes is not required. |

4.1.6 Right of Way

Right of Way (ROW) is defined as “servitude” in Uzbek legislation. The required size of the ROW for an OHTL is determined under SanPiN No.0350-17 “For the Protection of Atmospheric Air in Populated Areas of the Republic of Uzbekistan” (2017), which defines health protection zones (HPZ), which are also known as setbacks, for OHTL’s.

According to SanPiN No.0350-17, section 2.23.4, an HPZ must be established to protect the population from the effects of an OHTL’s electrical field. HPZ’s are defined as the land along the route of a high-voltage OHTL in which the electric field strength exceeds 1 kV/m. For newly designed OHTLs, buildings and structures must be set back the following distances either side of the OHTL.¹⁰

- 20 m for OHTL with a voltage of 330 kV
- 30 m for OHTL with a voltage of 500 kV
- 40 m for OHTL with a voltage of 750 kV
- 55 m for OHTL with a voltage of 1150 kV

As a result, current Project will require HPZ as 30 m from each outermost conductor.

ROWs are also required for operation and maintenance of the OHTL, for example no houses, or tall structures can be built and no tall trees can be grown in the OHTL ROW so as not to obstruct the cables, and also to allow access for maintenance vehicles to conduct maintenance activities.

The main regulations for obtaining ROW are the Land Code of Uzbekistan (Article 30 and 86), and the Civil Code (Article 173) as well as the Resolution of Cabinet of Ministries No.911 dated on 16.11.2019.

LC, Article 30, recognises following cases for obtaining a ROW:

- Placing transmission, communication, engineering and other types of line through the land;
- Construction of irrigation canals, or performing drainage work on the land;
- Construction of wells to get a water for drinking purposes;
- Using part of the land as an access road; and

¹⁰ The HPZ (set back) is defined as the distance from the outermost wires in a direction perpendicular to the OHTL.

- Conducting research or other temporary field works.

The above listed legal acts require that a mutual agreement between the current landowner and the entity that needs the land plot must be made in order to obtain a ROW. ROW should also be legally registered and contain all conditions that were agreed between the two parties. Moreover, all losses/damages occurred as a result of the activities carried out to prepare the ROW are subject to compensation.

If a ROW is required on lands that are intended for agricultural purposes, the quality of soil should be monitored frequently. If the company using the ROW damages the remaining pieces of land, it should be compensated as well.

Requirements for calculation and compensation of losses as a result of obtaining a ROW are the same as for all other types of land acquisition.

4.2 EBRD Performance Requirements

EBRD's resettlement and livelihood restoration requirements are primarily found in PR5 - Land Acquisition, Restrictions on Land Use and Involuntary Resettlement and PR 10 - Information Disclosure and Stakeholder Engagement.

PR5 "recognises that involuntary resettlement can result in long-term hardship and impoverishment for affected persons and communities in areas to which they have been displaced. Involuntary resettlement refers both to physical displacement (loss of assets or resources, and/or loss of access to assets or resources that leads to loss of income sources or means of livelihood) as a result of project-related land acquisition and/or restrictions on land use"¹¹.

Requirements of PR5 are as follows:

- Avoid or when unavoidable, minimise, involuntary resettlement by exploring alternative project design;
- Mitigate adverse social and economic impacts from land acquisition or restrictions on affected persons' use of and access to assets and land by: (i) providing compensation for loss of assets at replacement cost; and (ii) ensuring that resettlement activities are implemented with appropriate disclosure of information, consultation and the informed participation of those affected;
- Restore or, where possible, improve the livelihoods and standards of living of displaced persons to pre-displacement levels; and
- Improve living conditions among physically displaced persons through the provision of adequate housing, including security of tenure at resettlement sites.

PR5 applies to physical and/or economic displacement resulting from the following types of land-related transactions:

- Land rights or land use rights acquired through expropriation or other compulsory procedures in accordance with the legal system of the host country;
- Land rights or land use rights acquired through negotiated resettlements with property owners or those with legal rights to the land including customary or traditional rights recognised or recognisable under the laws of the country, if expropriation or other compulsory process would have resulted upon the failure of negotiation; and

¹¹ EBRD, Performance Requirement 5 (in EBRD ESP 2019)

- Imposition of restrictions that result in people experiencing loss of access to physical assets or natural resources irrespective of whether such rights of restriction are acquired through negotiation, expropriation, compulsory purchase, or by means of government regulation¹²

PR10 requires developers to:

- Outline a systematic approach to stakeholder engagement that will help clients build and maintain a constructive relationship with their stakeholders, particularly the directly affected communities;
- Provide means for effective engagement with the project’s stakeholders (including land users) throughout the project lifecycle;
- Ensure that appropriate environmental and social information is disclosed, and meaningful consultation is held with the project’s stakeholders and where appropriate, feedback provided through the consultation is taken into consideration; and
- Ensure that grievances from affected communities and other stakeholders are responded to and managed appropriately.

Specific stakeholder engagement related requirements for the land acquisition process include the need to ensure affected persons will be given the opportunity to participate in determining the eligibility requirements, in negotiations of the compensation packages, selecting resettlement assistance and proposed timing for land acquisition and livelihood restoration activities. Consultation must continue during the implementation, monitoring and evaluation of the land acquisition process so as to achieve outcomes that are consistent with the objectives of EBRD PR10.

4.3 Gap analysis between EBRD Performance Requirements 5 and 10 and national regulations

The Uzbek legislation included in section 4.1 does not match/cover several requirements of EBRD’s requirements for conducting resettlement and livelihood restoration activities. Differences and gaps between Uzbek legislation and EBRD requirements are summarised in Table 2 below.

Table 2: Main gaps between national legislation and EBRD PR5 and PR 10

| Element | EBRD PR5 | Uzbekistan Legislation | Measures to bridge the gap |
|---------------------------------------|---|--|--|
| Avoid or minimise displacement | The Project Developer should avoid, and if it is not possible, to minimize physical and/or economic displacement. | GoU as owner of all land in the country can acquire land plots for state and public needs, especially in cases when land is needed to improve state services, socio-economic state of the region or for important investment projects. | NEGU will consider all impacts to local land users and propose the best option that will minimize impacts. |

¹² This includes those with no recognisable legal right or claim to the land they occupy.

| Element | EBRD PR5 | Uzbekistan Legislation | Measures to bridge the gap |
|---|--|--|---|
| Planning process | The Project Developer should develop a resettlement/ livelihood restoration plan to avoid risk and impacts associated with the project. | GoU requires only to obtain the right for land as per prescribed procedures and ensure that compensation is paid to affected people. | NEGU will prepare an LRP in accordance with PR5 requirements. |
| Eligibility for compensation | The Project Developer should carefully examine potentially impacted people/all land users and set up an entitlement matrix of those who are eligible for compensation. | Uzbek legislation recognises legal landowners only. (in this case, LLCs are only considered as legal land leaseholder). Herders work for LLC and not all of them have a legal employment contract. | The Project will identify all land users as being eligible for compensation as per EBRD PR5. |
| Compensation and benefits for displaced people | The Project Developer will offer economically displaced communities and people compensation for loss of assets at full replacement cost and compensate for any loss of income during relocation. | Compensation under the Resolutions of the Cabinet of Ministries N911 and N146 is determined in accordance with the prevailing market price after considering the value of land, cost of structures (residential and business) and installations, crops, forest land and timber. It also covers compensation for transaction costs. | The market value (as determined by a registered evaluator) and transaction costs will be used to reach replacement cost. Lost income during the transition (if required) will be provided to all eligible people as per EBRD PR5. |
| Compensation for loss of livelihood | Where livelihoods are displaced the Project Developer will offer the PAPs land-based compensation / non-monetary compensation. | Lessors of Government land are not financially compensated, however there are offered land-based compensation mechanisms that enable renegotiation of the land lease and / or land-based compensation equivalent to the land lost. | The Project will provide all eligible people with compensation for existing and future loss of livelihoods. |
| Compensation payments | The Project Developer must only take possession of land once all compensation has been made available. | Land can be acquired from the current owner and resettlement can take place only after provision of compensation. | No gap. No construction will take place until compensation payments are completed. |

| Element | EBRD PR5 | Uzbekistan Legislation | Measures to bridge the gap |
|---|--|--|---|
| Provision of benefits | Displaced persons must be given the opportunity to derive benefits ¹³ from the project. | Not addressed. | Where applicable the Project will provide access to Project benefits for PAPs. This includes inclusion in ongoing consultation, priority for hiring purposes, and inclusion in livelihood restoration activities. |
| Inventory of affected assets & establishment of a cut-off date | The Project Developer should announce cut off dates for all identified PAPs and conduct an inventory survey. | No cut off dates are required by local legislation. Inventory survey is conducted at the cost of PAP or entity requiring land acquisition. | The Project will conduct negotiations with all identified land users, agree on cut-off date and publicly disclose it. Inventory survey will be performed by NEGU in the presence of the property owner. |
| Vulnerable groups | Vulnerable groups should be aware of their rights for compensation. It also requires that the project developer provides additional support apart from compensation, depending on the basic needs of the PAPs. | No specific support, such as additional support in non-material form, to vulnerable groups is requested by local legislation. While receiving compensation in a monetary form some privileges on taxation can be applied as per the Tax Code only. | Vulnerable groups identified will be provided assistance in accordance with EBRD, requirements. |
| Information disclosure | The project developer should regularly arrange meetings with stakeholders as well as PAPs and inform them about the Project status. | Information disclosure is not required as per local legislation. | The Project will provide PAPs with GRM details and arrange meetings throughout the LRP process. |
| Stakeholder consultations | The project developer must ensure that all PAPs are informed at the early stage of project and consulted. | Local legislation requires consultations with relevant municipalities only. As a result, PAPs are not able to participate in decision making process. It will only be necessary to obtain an agreement from the | NEGU will inform all land user at an early stage of Project planning, as well as other relevant stakeholders, and throughout the LRP process. |

¹³ Benefits may include local hiring, corporate social responsibility opportunities, and project specific benefits e.g. improved road access.

| Element | EBRD PR5 | Uzbekistan Legislation | Measures to bridge the gap |
|---|--|--|--|
| | | current landowners for the ROW. | |
| Grievance mechanism | The project developer should establish a mechanism for communicating with stakeholders and PAPs as per PR5 and PR10. All grievances received through the grievance mechanism should be addressed in a timely manner. | As per local regulations PAPs are eligible to submit complaints to any relevant state organisation. No separate grievance mechanism needs to be established. However, there is no formal grievance redress under the law in relation to loss of livelihoods. | The Project will establish a standalone GRM (a temporary GRM is in place (see section 14) until JEC NEGU assumes full responsibility of this LARF. This will allow PAPs directly communicate with JSC NEGU or its Main Contractor. |
| Monitoring of LRP/RAP Implementation | Consultations are required at all stages: implementation, monitoring, and evaluation of compensation payments. | No monitoring is required. | NEGU will establish a dedicated plan for monitoring and evaluation of the LRP. |

5 Affected people and assets

Based on the site investigations and consultations conducted during the November 2021 site visits, it is expected that the main Project involuntary resettlement impacts are going to be loss of income arising from temporary and permanent loss of grazing land for local Limited Liability Companies (LLCs) and herders.

To determine the status of land ownership as well as other types of land use of affected land, JE issued letters to Khorezm and Bukhara regional municipalities in November 2022. The Gijduvan department of State Cadastral Agency under the Tax Committee of the Republic of Uzbekistan has stated (in letter N15-1546, 09.12.2021) that land with a size of 6,000 ha along Lot 2 is owned by the State Committee on Sericulture and Wool Industry Development. The Committee became a landowner of all pasture lands in Uzbekistan as per Presidential Decree 6059 dated 2.09.2020. Tuprokkala department of the State Cadastral Agency stated that 40,500 ha of land, including the proposed route for Lot 1 has been allocated to the same Committee.

The following table (Table 3) provides an overview of the estimated area that will be impacted by the Project. It provides a breakdown of the areas that will be permanently and temporarily impacted and the ownership rights of the land. The estimation of permanent land acquisition depends on the distance between towers which has not yet been determined and could be between 300m to 500m, depending on the type of tower selected. Therefore, it is estimated that

the Project will permanently acquire the rights to between 6850 m² and 11,400 m² of land and will permanently gain the servitude rights for 8,360,000 m² of land (this could be reduced by 140,000 m² to 8,220,000 m² if the access road is located within the right of way, which is a high possibility).

Table 3: Land required for the Project

| Land type | Permanent/ temporary | Area (m ² /m) | Land use rights |
|---------------------|--------------------------|--|--|
| Lot 1 | | | |
| Tower footprints | Permanent (acquisition) | Between 6,350m ² and 10,575 m ² ¹⁴ | Dzhankeldy LLC |
| Right of way | Permanent (right of way) | 7,620,000 m ² ¹⁵ | Dzhankeldy LLC (official land lease) |
| | | 235.62 m ² ¹⁶ | Herders 1,2 & 3 (usage rights given by Dzhankeldy LLC) |
| Access road | Temporary | 140,000 m ² ¹⁷ | Dzhankeldy LLC (official land lease) |
| Laydown areas | Temporary | 1,500 m ² ¹⁸ | Dzhankeldy LLC (official land lease) |
| Lot 2 | | | |
| Tower footprints | Permanent (acquisition) | Between 500 m ² and 825 m ² ¹⁹ | Kokcha LLC (official land lease) |
| Right of way | Permanent (right of way) | 600,000 m ² ²⁰ | Kokcha LLC (official land lease) |
| | | 157.08 m ² ²¹ | Herder 4 (usage rights given by Kokcha LLC) |
| Laydown areas | Temporary | 600 m ² ²² | Kokcha LLC (official land lease) |
| TOTAL Permanent | Permanent | Between 6850 m ² and 11,400 m ² (0.0069 km ² and 0.0114 km ²) | |
| TOTAL Temporary | Temporary | 8,360,000 m ² (8.36 km ²) | |
| TOTAL area required | | Between 8,366,850 m ² and 8,371,400 m ² (8.366 km ² and 8.371 km ²) | |

Note: The area attributed to herders is not included in the total as it is already calculated within the permanent right of way.

¹⁴ Between 254 and 423 towers * 25 m² (each tower) = 6,350 to 10,575 m²

¹⁵ 127 km (length of Lot 1) * 60m (width of the ROW) = 7,620,000 m²

¹⁶ Assumed as the worst-case scenario, the whole grazing radius of each herder (5 m) it is most likely that only a small section of the grazing radius will be impacted. 78.54 (area of a circle with 5m radius) * 3 (number of herders) = 235.62 m²

¹⁷ 35 km (temporary access road distance) * 4 m (estimated width) = 140,000 m².

¹⁸ 5 locations (assuming three worker accommodation sites and two laydown areas, one at each end of the OHTL) * 300m² (approximate area of the laydown areas) = 1,500 m²

¹⁹ Between 20 and 33 towers * 25 m² (each tower) = 500 to 825 m²

²⁰ 10 km (length of Lot 2) * 60m (width of the ROW) = 600,000 m²

²¹ 78.54 (area of a circle with 5m radius) * 2 (number of herding areas) = 157.04 m²

²² 2 locations (assuming one worker accommodation site and one laydown area) * 300m² (approximate area of the laydown areas) = 600 m²

There were no assets identified as being impacted along the proposed route both for Lot 1 and Lot 2, therefore only economic displacement impacts were identified. The following table (Table 4) provides an estimation of the total number of displaced persons (DPs) as a result of the Project. These DPs include herders, their families, their employees and the families of their employees (as relevant). Overall it is expected that construction of Lot 1 will result in 12 DPs and Lot 2 will result in 3 DPs in terms of grazing land. The majority of impacts are expected to be temporary, i.e., DPs will be limited in their grazing activities undertaken near the Project only during construction works.

Table 4: Estimated number of displaced persons

| Land type | Permanent/ temporary | Number |
|-------------------|----------------------|--------|
| Lot 1 | | |
| Displaced persons | Permanent | 0 |
| | Temporary | 12 |
| Lot 2 | | |
| Displaced persons | Permanent | 0 |
| | Temporary | 3 |
| TOTAL | Permanent | 0 |
| | Temporary | 15 |
| TOTAL DPs | | 15 |

Considering that the LLCs have no prescribed borders to the land established for grazing, DPs will likely be able to move further afield and offset the areas that will be limited for grazing as a result of construction works.

The impact on the DPs is expected to be temporary, occurring only during the construction phase, and the impacts are likely to be restricted to livelihoods as no assets have been identified as impacted. However, the sensitivity of the herders is high, given their vulnerability and low capacity to absorb project changes. In addition, the OHTL route has not been finalized and there may be some changes to Project impacts as a result of the construction of the Bash 500MW wind farm as Lot 2 is located within the wind farm’s AOI. Therefore, DPs and the impacts to them will need to be confirmed once the final design has been prepared and the resulting impacts of the Bash wind farm are known. A Livelihood Restoration Plan (based on the information included in this LARF), as per EBRD PR5 will need to be prepared for all impacts identified at that time.

The following sections provide information on the LLCs and the location of herders in the two Project Lots (further detail is provided in Appendix A).

5.1 State Committee on Sericulture and Wool Industry Development

The Dzhankeldy and Kokcha LLCs are subordinate organisations of the State Committee of the Republic of Uzbekistan on Sericulture and Wool Industry Development. This Committee controls

separate departments in each region of Uzbekistan. These departments monitor and regulate activities of the LLC's use of grazing land and upkeep of the Committee's livestock.

As per Presidential Decree No. PD - 6059 dated 2.09.2020 "On measures for the further development of Sericulture and Karakul breeding in the Republic of Uzbekistan" all pasture lands in the country were allocated to the Committee for unlimited use.

For information: On July 8, 2021 by Presidential Decree (PD5178) thr Committee on Sericulture and Karakul breeding was renamed to State Committee of the Republic of Uzbekistan on Sericulture and Wool Industry Development

The Committee was established by the President of the Republic of Uzbekistan in 2020, to:

- Pursue a unified state policy in the field of animal husbandry, ensuring the coordinated development of industries with a unified scientific and technical policy;
- Maintain strict accounting and study of mulberry plantations and pastures, improving the fodder base for the development of sericulture and astrakhan breeding;
- Introduce highly productive breeds of silkworm and karakul sheep;
- Create favourable conditions for the procurement and processing of raw materials for the production of finished products from silk and astrakhan fur;
- Conduct market research and assistance in the sale of silk and karakul products, primarily in foreign markets; and
- Provide comprehensive assistance to business entities engaged in silkworm breeding and karakul sheep breeding, in expanding their activities, creating clusters and exporting products.

To create favourable conditions for functioning of the Committee the GoU has allocated all pasture land throughout the country for the Committee's unlimited use. Moreover, the GoU supports the Committee by providing tax exemptions on the land.²³

²³ <https://lex.uz/docs/-4980311>

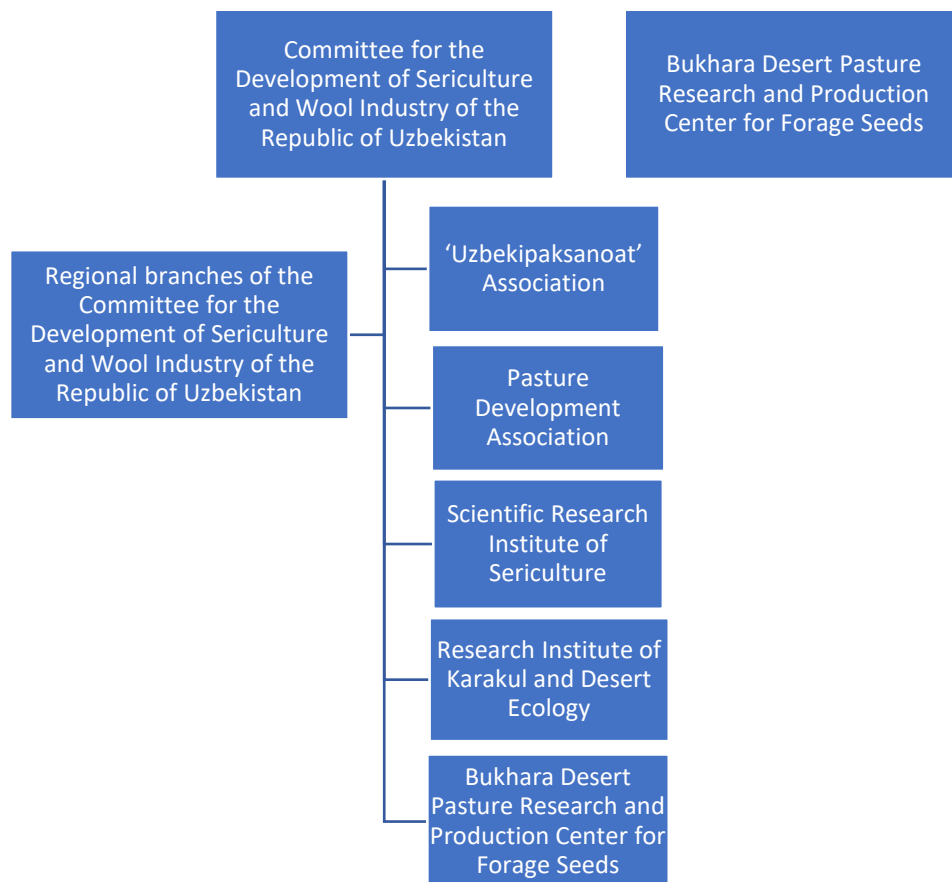

Figure 8: Organisational structure of Committee

Source: State Committee on Sericulture and Wool Development Industry

5.2 Lot 1

As per consultations with the Khorezm Region Municipality the land for the proposed route from Sarimay Substation to the planned substation at Dzhankeldy wind farm (Lot 1) is owned by the Committee and leased to the Dzhankeldy LLC. Along Lot 1 it is expected that Dzhankeldy LLC will be mainly affected by land loss and loss of income and the three herders whose grazing areas might be impacted by construction works and may also be affected by a loss of income.

Dzhankeldy LLC's headquarters are located in Peshku district of Bukhara region. Dzhankeldy LLC is responsible for all organisational and managerial works, such as hiring herders and allocation of land plots for grazing. Usually for grazing one sheep or goat 2.5-4 ha land is required. Since it is pretty difficult to manage livestock and keep it in one place during grazing, LLCs do not specify the specific borders of land for a hired herder. This LLC owns 10,000 heads of sheep and goats, 1,000 heads of camels, and 150 heads of horses.

Dzhankeldy LLC is empowered to build structures on the land leased from the Committee (e.g. settlements, wells, stables etc). If a herder wants to construct any assets on the land managed by Dzhankeldy LLC, it is necessary to get an agreement first from the LLC.

Each identified herder was interviewed separately. The distance herders' settlements are located from the Project sites are summarized in Table 5.

Table 5: Distance of herders' settlements in relation to OHTLs (Lot 1)

| No | Herder ID | Distance to Project | Number of employees |
|----|-----------|---------------------|-----------------------------------|
| H1 | Herder 1 | 820 m | Two employees plus family members |
| H2 | Herder 2 | 1.4 km | Family members occasionally |
| H3 | Herder 3 | 80 m | Family members |

Herder 1 constructed a settlement in 2005 that is located 820 m from Lot 1. He uses this settlement all year round. Before the founding of the State Committee on Sericulture and Wool Industry Development (2020) he rented 10,000 ha of land, which was registered as Dilfuza-Azizbek farm. However, in 2020 based on Presidential Decree (PD 6059) all pastoral land in this area, including his farm were allocated for unlimited use to the Committee.

This land was leased to him by Romitan municipality (Bukhara region) in 2017 for 49 years for the purpose of keeping livestock. Herder 1 now works for Dzhankeldy LLC as a herder. The LLC did not indicate a specific area to graze the livestock, so the herder uses a radius of approximately 5 km from his settlement. He herds camels for Dzhankeldy LLC as well as his own livestock.

Herder 1 involves his wife to assist him in his grazing activities. He also hires two workers, both of them are paid a monthly salary.

Figure 9 shows that the alignment of the OHTL (the blue line) has been modified to avoid the water station, which is between his settlement and the OHTL ROW. However, the OHTL ROW does cross the radius of his grazing land.

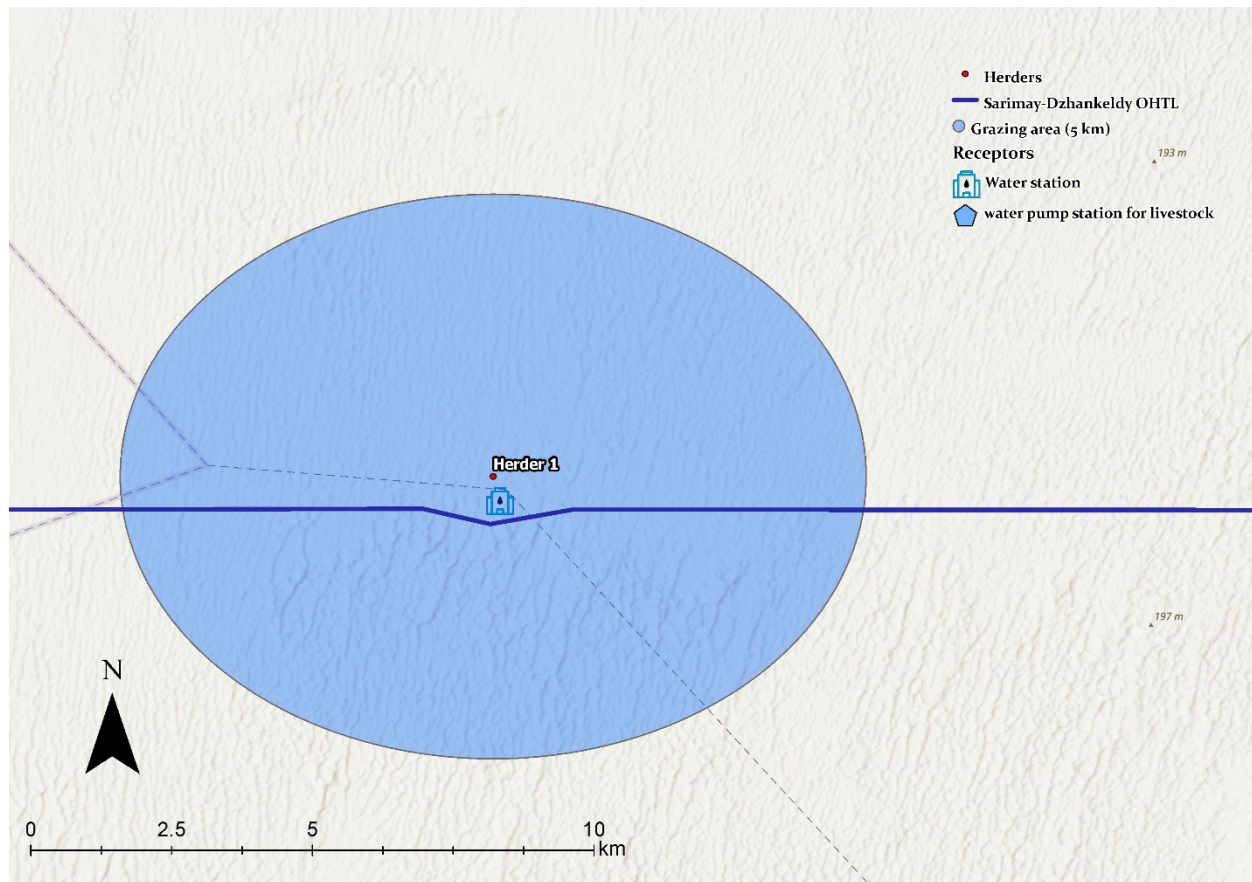

Figure 9: Preliminary grazing area of Herder 1

Herder 2 uses a small housing structure where he lives while using the land. It is a distance of 1.4 km from the Project ROW. This structure is owned by Dzhankeldy LLC and he uses this house all year round.

Herder 2 works as a herder for Dzhankeldy LLC and he grazes sheep and goats for Dzhankeldy LLC as well as his own livestock. Thus, he usually keeps livestock in a radius of 5 km from his settlement. He sometimes involves his wife and daughter in his grazing activities

Figure 10 shows that the alignment of the OHTL (the blue line) avoids his settlement. However, the OHTL alignment does cross the radius of his grazing land.

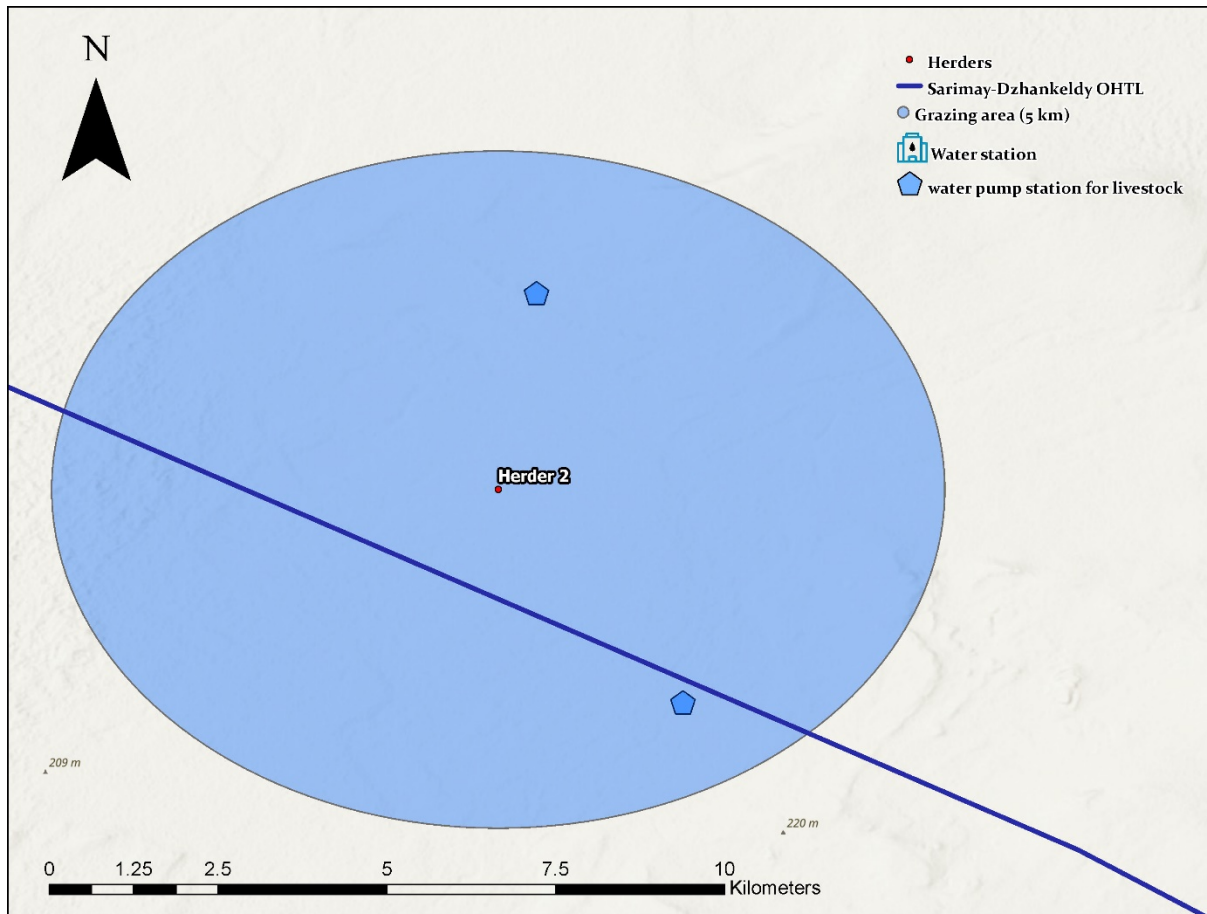

Figure 10: Preliminary grazing area of Herder 2

Herder 3 has a stable to keep livestock that is located 80 meters from Lot 1. His permanent residence is located approximately 20km from the stable. This stable is used during the breeding period three months, (February, March and April) and the herder resides at the stable during that time period.

Herder 3 works for Dzhankeldy LLC. He grazes camels for Dzhankeldy LLC and his own livestock. He involves his four sons to assist him in managing livestock.

Figure 11 shows that the alignment of the OHTL (the blue line) avoids his stable. However, the OHTL alignment does cross the radius of his grazing land.

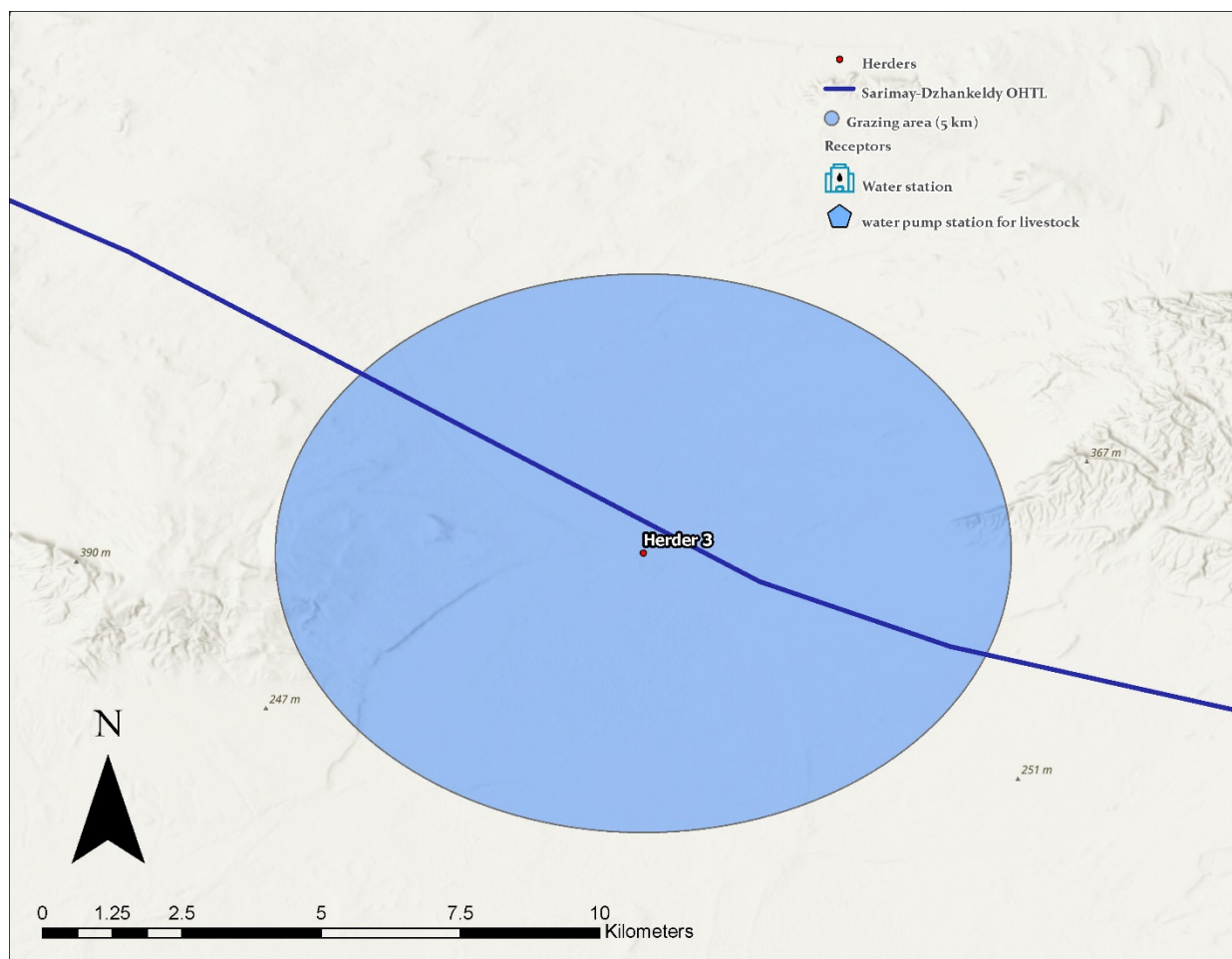

Figure 11: Preliminary grazing area of Herder 3

5.3 Lot 2

Kokcha LLC, located in Gijduvan district of Bukhara region, manages the land for Lot 2 which is leased from the Committee. This LLC will already be impacted by the construction of the Bash 500MW WF as the and proposed route for Lot 2 is located within the AOI of the wind farm. Kokcha LLC owns 15,194 head of sheep and goats, 43 head of camels, and 38 heads of horses²⁴.

All activities related to livestock raising in Lot 2 are carried out on behalf of the Kokcha LLC. Depending on the number of leased livestock as well as current state of the pastureland Kokcha LLC allocates 1.5 to 3 ha of land per sheep or goat.

Regarding the support to herders, Kokcha LLC provides free veterinary services, assists with water supply (digging wells), construction of structures like stables and settlements. Herders are not eligible to construct settlement or any assets without notification and the agreement of Kokcha LLC.

Within construction of the Lot 2 ROW it is expected that one herder may be impacted as he grazes livestock with a 1.5 km radius of the proposed route for Lot 2. This herder has two different settlements that may be impacted by the Project as summarised in Table 6.

²⁴ Bukhara region department of the Committee for the Development of Sericulture and Wool Industry.

Table 6: Distance of herders' settlements in relation to OHTLs (Lot 2)

| № | Herder ID | Distance to Project | Employees |
|----|-----------|---------------------|---------------|
| H4 | Herder 4 | (H4.1) 390 m | Two employees |
| | | (H4.2) 670 m | |

Herder 4 has two seasonal settlements along Lot 2. He grazes sheep belonging to Kokcha LLC and his own livestock. He grazes his livestock all year round and has two settlements (H 4.1 and H 4.2 on Figure 12). The herder uses the northern part of Project site for grazing, and does not cross the railway line. He uses all of the area surrounding his settlements.

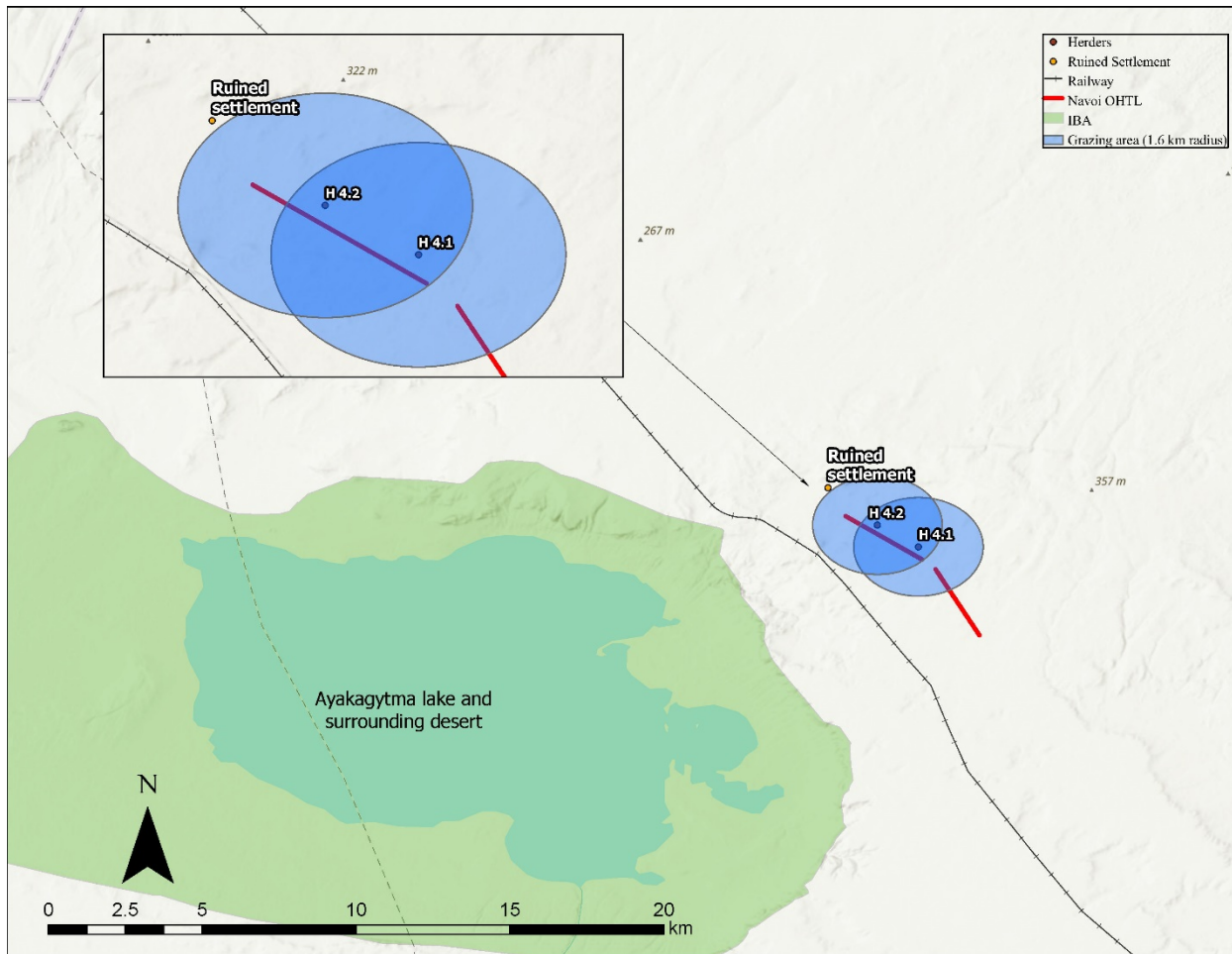

Figure 12: Preliminary grazing area of Herder 4

Herder 4 hires two workers under verbal agreements to help undertake his grazing activities. Herder 4 uses the land for livestock activities all year round. Herder 4 constructed the two settlements in 2005. However, he does not have any legal permissions, nor cadastral documents for the construction of the facilities.

5.4 Scope of economic displacement

In order to determine the amount of land which is required for land acquisition (for the tower footprints) and servitude (for the ROW) NEGU will need to:

- Confirm the final ROW for both for Lot 1 and Lot 2 (outline 30 meters from each side of tower for HPZ) and ensure that requirements for HPZ are followed.
- Estimate placement of towers to be placed along both Lot 1 and Lot 2;
- Provide the size of towers in order to determine exact size of footprint for permanent use;
- Determine the size of the ROW based on the tower placement; and
- Outline additional land required for temporary laydown areas and access routes needed for the construction that may impact herders as a result of temporary land acquisition.

6 Key compensation and assistance principles

Compensation principles should be based on rules prescribed by local legislation as well as requirements indicated in PR5. The following sections provide an overview of the process by which, compensation will be paid for this Project.

6.1 Land acquisition process

NEGU, the State Committee on Sericulture and Wool Industry Development and the two LLCs are all government organization, and therefore the land acquisition process between these entities will necessarily follow the applicable national legislation. In these cases, NEGU will review the national requirements and compensation are compliant with ERBD requirements and make adjustments as necessary.

There are other impacts, particularly impacts on PAPs without leases/contracts, or with impacts that are not compensated under national legislation, that will exclusively follow the EBRD requirements.

In either case, no land will be handed over to the contractors until the land acquisition process has been completed and all compensation payments have been made. Contractors will not be able to start work until EBRD has certified that the Project implementation has been undertaken in line with PR5.

6.1.1 Government requirements

The first step in the national process is that NEGU will prepare presentation materials and submit them to the Turtkul khokimiyat (Republic of Karakalpakstan), Tuprokalla khokimiyat (Khorezm region), Peshku and Gijduvan khokimiyats (Bukhara region) and Bukhara Regional Department for the Committee on Sericulture and Wool Industry Development.

The khokimiyats will send an inquiry to the District Construction Departments and district branches of the Cadastral Enterprise in order to obtain the relevant information, i.e., verify land plot sizes, owners, and obtain the latest version of the required land plot map.

Within five working days from the date of receiving the inquiry two things will happen:

- The District Construction Department will prepare and submit, to the khokimiyat, information on the compliance of Project documentation with the general plan of the land to be acquired (in the absence of the general plan, schemes of the land plot location, can be issued for business activity); and
- District branches of the Cadastral Enterprise will prepare a list of real estate located on the land plot and submit it to the khokimiyat.

The Peshku and Gijduvan district khokimiyats, within two working days from the date of receipt of relevant reports and other information, will send NEGU the full list of real estate located on the given land plot.

NEGU, within five working days from the date of receiving the full list of real estate located on this land plot, will:

- Determine the initial amount of compensation to owners of real estate in accordance with the procedure established by law; and
- Provide the khokimiyats with documents confirming that there are sufficient funds to pay compensation.

The presentation materials will be sent to the Council of People's Deputies to obtain a decision on the land acquisition within two working days from the date of receipt of the presentation.

The Council of People's Deputies will review the documentation provided to consider the following issues:

- whether the Project is aimed at infrastructure development;
- whether the opinion of the majority of community members has been taken into account;
- that empty buildings and unused land plots for Project implementation have been identified and proposed as alternatives; and
- that alternative land plots have been selected in case of absence of such objects or land plots.

The Council of People's Deputies will make a decision on the land acquisition and disclose its decision.

NEGU will undertake consultations with the land leaseholders and will obtain 'prior consent' for the land acquisition, if required.

NEGU will organize that an a valuation is undertaken of the market value of any losses, it will also determine costs associated with moving, loss of profit and any other relevant expenses. These values will be discussed with the property owner to agree compensation and a written agreement will be produced. The regional khokimiyats will monitor the contracts and issuance of compensation.

The property owner will need to make sure that the property is completely free of liens and available to transfer at which point the khokimiyat and judicial authorities complete the required decision documents and authorize the Project to take over the land and start any required demolition.

6.1.2 EBRD requirements

The mahallas and khokimiyats will be approached to collect data to identify any further PAPs or entities with legal claims to the required land (this is not considered likely as the Committee on Sericulture and Wool Industry Development owns the rights to all of the land in the Project location).

A census survey and socioeconomic survey will be undertaken of all land required for the Project to identify eligible PAPs (see section 6.3) and their losses, it is likely that the two surveys will be undertaken simultaneously. PAPs will be consulted prior to the implementation of the surveys in order to disclose the purpose of the surveys and disclose the cut-off date (discussed further below). The surveys will cover the following:

- Census survey – determines the number of people impacted and makes a detailed inventory of the Project losses to each household (including land size, structures, crops and trees, income and employment).
- Socio-economic survey – provides a baseline of the PAPs that can be used for future monitoring to determine if PAPs are better or worse off as a result of the Project. It will include household demographics, health, education, income and expenditure among others. All data will be gender disaggregated where possible.

A cut-off date will be determined and disclosed to PAPs and local communities. Following the cut-off date, no newly identified impacts will be compensated. The date will likely be the final date of the census survey and socioeconomic survey.

Once impacts are identified a Livelihood Restoration Plan (LRP) will be prepared and, compensation will be calculated for all PAPs. NEGU will employ an independent valuer to determine the full replacement cost to determine compensation. Where possible contracts will be negotiated PAPs to determine final compensation. The results will be kept in a database for reference.

Livelihood restoration activities will be determined in consultation with PAPs and included in the LRP. Once determined, they will be implemented as soon as possible in the land acquisition process. Depending on the types of activities identified, they may continue into the construction phase.

NEGU will be responsible for payment of compensation to PAPs. The method of payments will be transparent and accessible to all PAPs. It will be determined by NEGU and disclosed in the LRP.

Consultation will be maintained throughout the process with PAPs, district khokimiyats, local communities, local leaders and other relevant stakeholders. PAPs will also have access to the grievance mechanism (see section 15) throughout the land acquisition process.

6.2 Servitude process

As described in the legal framework section (section 4), cases of servitude, or limited right to use of land, can be obtained as per Article 30 of the Land Code of the Republic of Uzbekistan. Similar to the land acquisition process, in order to obtaining the right to servitude it is necessary to provide the needs case/justification for the use of the land. The application for servitude can be submitted either to the local municipalities or the two parties (the Project developer and the land leaseholder - in this case the LLCs), can come to a mutual consent and make a legal agreement.

Among the services of e-governance of Republic of Uzbekistan registration of servitude can be done via submitting an e-application through the e-portal to my.gov.uz. The service is provided by branches of the State Enterprise of Land Management and Real Estate Cadastre of Karakalpakstan, regions of Uzbekistan and Tashkent city.

It is the intention of the Project to come to a negotiated agreement for the servitude rights. However, under national law, if the parties do not come to a mutual agreement, the right to servitude can be resolved with a court decision.

6.3 Implementation process

Table 7 provides an overview of the implementation of the Projects following national law and EBRD PR5 (Note: PR5 does not include a specific timeframe for undertaking the required activities). It shows the actions required under both land acquisition and servitude.

Table 7: Implementation process

| Phase | Responsible parties | Legal requirement | Land Acquisition | Servitude | Legal time frames | EBRD Requirements | Inputs/ outputs required |
|---------|---|---|------------------|-----------|--------------------------------|--|---|
| Phase 1 | Project developer – NEGU / President of Uzbekistan / Cabinet of Ministers | Makes a decision. | X | X | If required ²⁵ | Not required. | Request to relevant governing bodies Response from President or relevant body |
| Phase 2 | Project developer – NEGU / Khokimiyats | Provides information on presence of old/ruined or dangerous buildings/structures on land plot which is necessary for project. | X | X | If required | Not required. | Request to relevant khokimiyats |
| | | Confirms availability of land, i.e, required size, amount of real estate/assets, if any. | X | X | If required | Not required. | Orders for construction issued by khokimiyat |
| | Project developer – NEGU /cadastral services | Not required. | | | | Project to identify land rights of PAPs. | Statement of Project land rights (to be used in project design and included in LRP) |
| Phase 3 | Committee of Sericulture and Wool Development of the Republic of Uzbekistan | Gives agreement for land allocation for Project. | X | X | Upon initiation of the process | Not required. | Lendlease agreement |

²⁵ The items reported as ‘if required’ in this table are not mandatory, especially if NEGU has an approved strategy signed by a relevant governing body, however the approved strategy has not been determined at the time of writing this LARF and therefore the need for these steps will be determined by NEGU when initiating the land acquisition process.

| Phase | Responsible parties | Legal requirement | Land Acquisition | Servitude | Legal time frames | EBRD Requirements | Inputs/ outputs required |
|---------|---|---|------------------|-----------|------------------------|-------------------|---|
| Phase 4 | Project developer - NEGU | Prepares presentation materials on the architectural part of the design documentation of the Project. | X | | If required | Not required. | Document package sent to relevant regional municipalities |
| | Khokimiyats | Sends an inquiry to the district construction departments and district branches of the cadastral enterprise in order to obtain the relevant information. | X | | Within 2 business days | Not required. | Response on outcomes of decision on Project |
| | Construction departments | Prepares information on the compliance of the design documentation of the Project with urban planning documents. | X | | Within 5 business days | Not required. | Written conclusion on the project |
| | | Sends materials to Khokimiyats in the established order. | X | | | | |
| | District (City) branches of Land Resources and State Cadastre Department | Prepares a full list of real estate objects that are located on the land plot to be acquired. | X | X | Within 5 business days | Not required. | Written conclusion on the project |
| | | Sends materials to Khokimiyats in the established order. | X | X | | | |
| | The Council of Ministers of the Republic of Karakalpakstan / regional district (city) / Tashkent city khokims | Offers a written proposal to property owners to exercise the right of priority in the implementation of the Project. | X | X | Within 5 business days | Not required. | Evidence of consultation with PAPs and Project Developer, if required |
| | Project developer/ NEGU | Provide justification/documents to the local authorities on availability of sufficient resources for implementation of the Project as well as consent from land/property owners on land acquisition/or servitude. | X | X | Within 2 months | Not required. | Justification of project need and ability to of NEGU to complete it (technical and financial resources) |

| Phase | Responsible parties | Legal requirement | Land Acquisition | Servitude | Legal time frames | EBRD Requirements | Inputs/ outputs required |
|-------|---|---|------------------|-----------|---|---|--|
| | | Not required. | | | | Undertake a census survey and socioeconomic survey. Establish a cut-off date. | Survey results Evidence of consultations to disclose surveys and cut-off date |
| | Khokimiyats | After reviewing provided documents khokimiyat will decide if the request for land acquisition can be satisfied or not. | X | | Within 2 business days of receiving the request | Not required. | Decision on provided package |
| | | Send to the Project Developer the full list of real estate objects located on the requested land plot. | X | | | Make a full list of all assets to be impact regardless of whether they were legally or illegally constructed. | List of PAPs and affected assets |
| | Project developer / NEGU | Determines the initial amount of compensation to be provided to the owners of real estate in accordance with the procedure established by law | X | X | Within 5 business days of receiving the request | Determine compensation for all impacted PAPs regardless of status of their rights (both for losses of assets with legal and illegal ownership). | Determination of compensation amounts Evidence of sufficient funds |
| | | Provide khokimiyats with documents confirming that there are sufficient funds to pay compensation. | X | | | | |
| | | Not required. | | | | Undertake negotiated settlement with PAPs. | Negotiated settlements |
| | | Not required. | | | | Prepare a Livelihood Restoration Plan. | Livelihood Restoration Plan |
| | Khokimiyats/ Council of People's Deputies | Sends the materials to the Council of People's Deputies to obtain a conclusion on the expediency of land acquisition. | X | | Within 2 business days | Not required. | Results of consultations and conclusion of land acquisition |
| | Jokorge Kenges of the Republic of Karakalpakstan or Councils of | Reviews the materials and makes a decision on the need to conduct Public Consultations. | X | | If necessary | Not required. | Decision on land acquisition |
| | | Announces the decision and sends it to Khokimiyats. | X | | Within 1 business | | |

| Phase | Responsible parties | Legal requirement | Land Acquisition | Servitude | Legal time frames | EBRD Requirements | Inputs/ outputs required |
|---------|--|---|------------------|-----------|---|---|---|
| | people's deputies of regions | | | | day of making decision | | |
| Phase 5 | Project developer/ NEGU | Informs the property owner of the implementation of public consultations. | X | | Within 2 business days | Provide continuous communication with PAPS. Inform PAPS on the status/timeline of project. Disclose information. Discuss impact assessment. | Evidence of public consultations and meetings with PAPS (meeting minutes, photographs etc). |
| | | Organizes public consultations. | X | X | Within 15 days | | |
| | | Makes protocols (MoM) and announces them. | X | X | On the day of public consultations | | |
| | | Obtains prior consent for land acquisition/servitude from the property owners. | X | X | If necessary | | |
| Phase 6 | Jokorge Kenges of the Republic of Karakalpakstan or Councils of people's deputies of regions | Makes a decision (positive or negative) on land acquisition. | X | X | Upon obtaining the prior consent from the owners | Not required. | Decision on land allocation (with justification of decision) Public announcement of decision |
| | | Announces the decision. | X | X | Within 5 working days after the public consultation | | |
| Phase 7 | Project developer / NEGU involving independent valuer | Organizes evaluation of rights to the land plot and market value of the real estate to be demolished. They also determine the amount of the following expenses: | X | X | As per agreement | Conduct inventory survey (discussed further above); Conduct socio economic surveys with PAPS; Determine full recovery cost for impacted assets. | Assessment of impact on land acquisition and compensation packages |
| | | - costs associated with moving to another place, time-bound rental; | X | X | | | |
| | | - loss of profit; | X | X | | | |
| | | - other expenses. | X | X | | | |

| Phase | Responsible parties | Legal requirement | Land Acquisition | Servitude | Legal time frames | EBRD Requirements | Inputs/ outputs required |
|---------------|--|--|------------------|---|--|---|--|
| Phase 8 | Project developer/ NEGU and property owner | Agrees on the types and amounts of compensation and the term of issue. | X | X | As per agreement | Disclose compensation packages and discuss it with PAPs individually. Consider PAPs comments/ concerns for compensation packages. | Evidence of consultations with PAPs |
| | Investor, property owners and Regional Khokimiyats | Concludes the written agreement and takes measures for notarial certification. | X | X | | Review compensation package, if required. | Written agreements |
| Phase 9 | Regional Khokimiyats | Takes into account contracts. | X | | Within the period specified in the agreement | Not required. | Monitoring reports Evidence of compensation payments |
| | | Monitors the issuance of compensation. | X | | | | |
| | Project developer/ NEGU | Provides the issuance of compensation stipulated in the contract. | X | | Within the period specified in the agreement | Not required. | |
| | | Not required. | | | | Payments made to PAPs in a transparent nature in a way that is easily accessible for all PAPs. | Evidence of compensation payments |
| | | Not required. | | | | Start livelihood restoration activities. | Evidence of livelihood restoration activities (such as monitoring reports) |
| Not required. | | | | Establishing the monitoring of compensation payment and | Monitoring reports | | |

| Phase | Responsible parties | Legal requirement | Land Acquisition | Servitude | Legal time frames | EBRD Requirements | Inputs/ outputs required |
|--|--------------------------------------|---|------------------|--|--|---|---|
| | | | | | | livelihood restoration activities. | |
| Phase 10 | Property owner | Frees completely residential houses, industrial premises and other buildings located on the land plot to be acquired (will take measures to resettle individuals living in residential houses). | X | X | Within the period specified in the agreement | Not required. | Land contracts |
| | Project developer/ NEGU | Not required | | | | Provision of transitional support to PAPs (where relevant). | Evidence of payment of allowances and provision of transportation |
| Phase 11 | Khokimiyats and relevant authorities | Prepares the draft decision and documents on demolition. | X | | Within 2 business days | Not required. | Preliminary decision |
| | | Sends the draft decision and documents on demolition to legal authorities. | X | | | | |
| | Juridical authorities | Considers the draft decision and documents on demolition. | X | | Within 2 business days | Not required. | Revision of received documents |
| | | Prepares a conclusion (positive or negative) to make a decision on demolition. | X | | | | Justifications for conclusion (both for positive and negative) |
| | | Sends the conclusion to the Khokimiyat. | X | | | | Outcomes in written form |
| | Khokimiyats | Makes a decision about demolition. Khokimiyat to inform relevant parties responsible for execution of order and make this order publicly available. | X | | If required | Not required. | Order issued and made publicly available Relevant parties informed |
| Sends the decision to the district offices of the cadastral organization and the district state tax authorities and announces it | | X | | Order issued and made publicly available | | | |

| Phase | Responsible parties | Legal requirement | Land Acquisition | Servitude | Legal time frames | EBRD Requirements | Inputs/ outputs required |
|----------|---|---|------------------|-----------|-------------------|---|---|
| | | on its official website and in the mass media. | | | | | |
| Phase 12 | Project developer/ NEGU or property owner | Organizes the demolition of the real estate, NEGU to take full responsibility for demolishing impacted assets/real estate etc and provide transitional support to PAPs. | X | | If required | Not required. | Demolition of structures Evidence of transitional support |
| | | Not required. | | | | Land to be developed and any demolition of structures to only be completed once all payments have been made for that section. | Evidence that all compensation has been paid prior to start of construction |

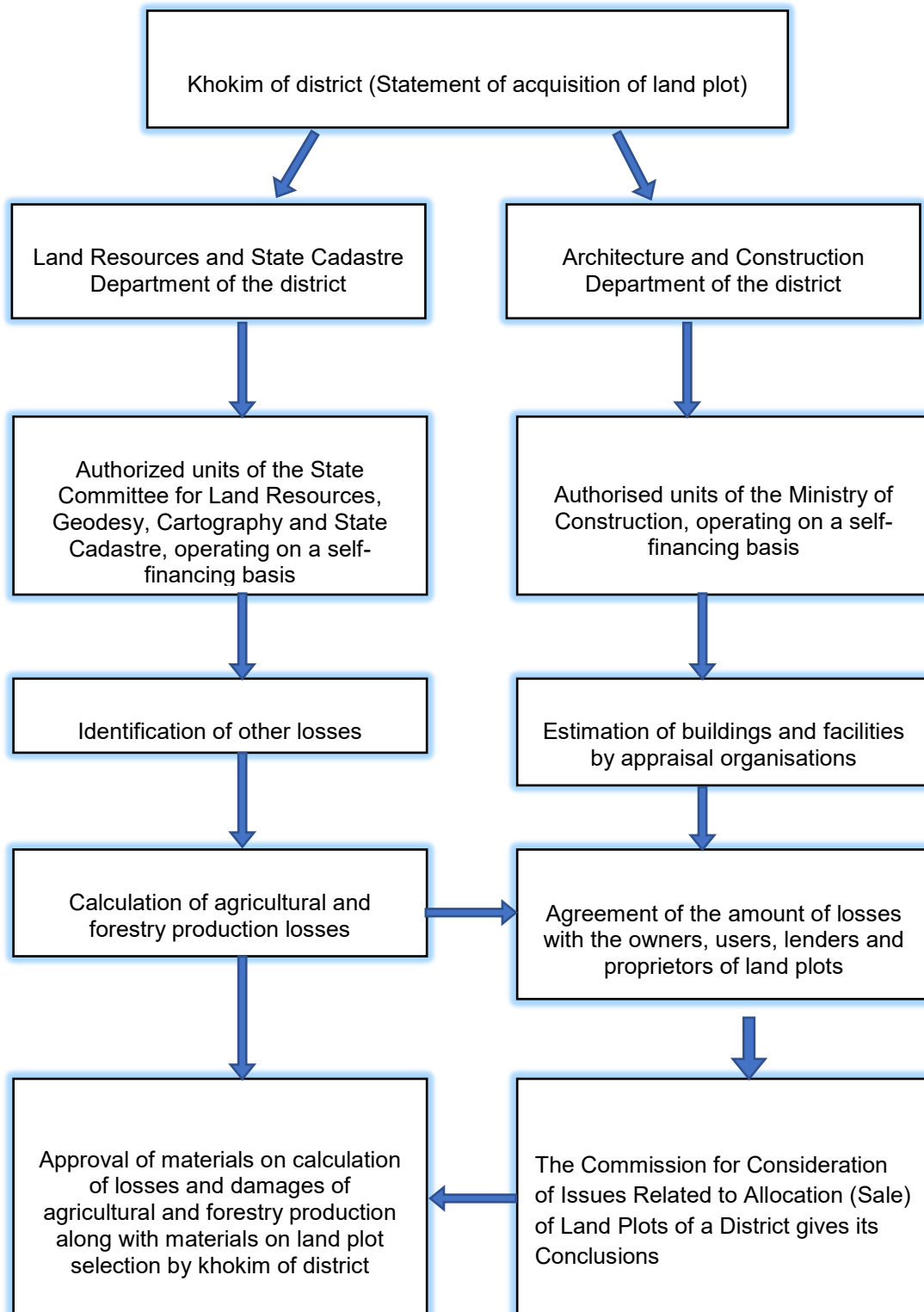

Figure 13: The scheme for calculating losses of owners, users, leaseholders and proprietors of land plots, as well as losses of agricultural and forestry production (where applicable)

Source: Annex 1 of Resolution 911 of the cabinet of Ministries

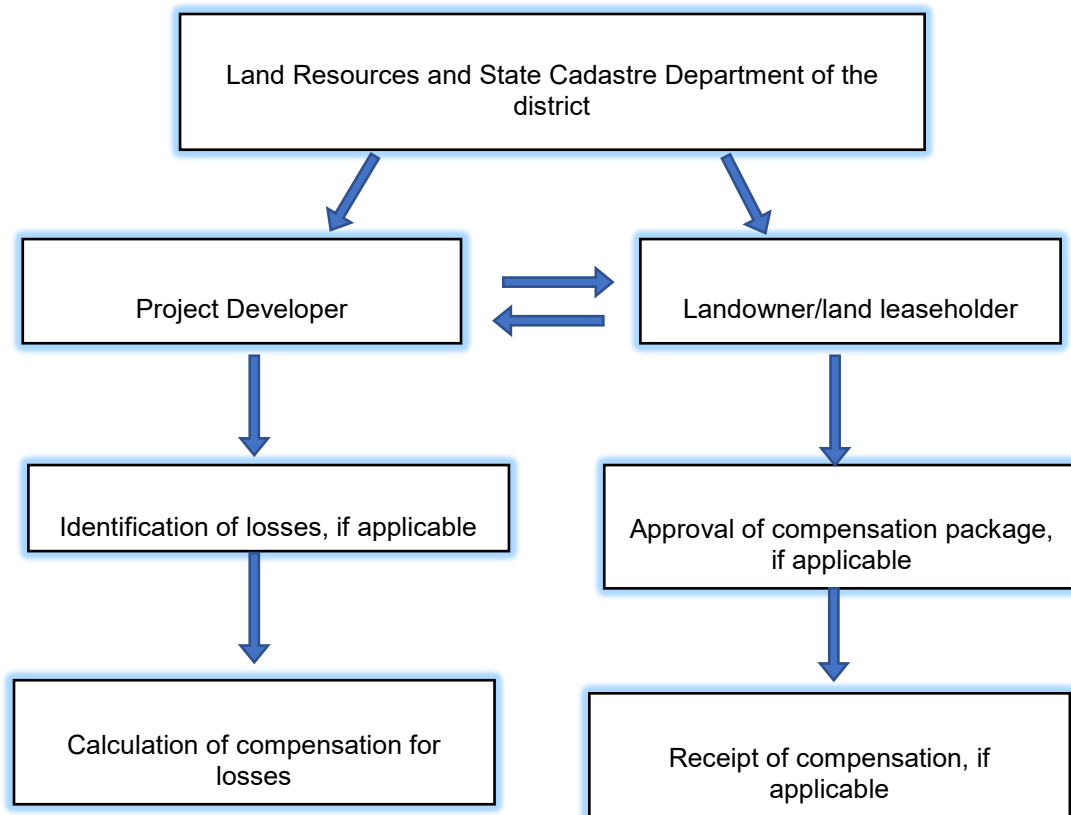

Figure 14: The scheme for servitude

Source: Annex 4 of the Resolution No146 of the cabinet of Ministries

7 Eligibility

Any person or company, whose assets and/or income is affected by the Project, whether permanently or temporarily, and regardless of whether or not they have legal title to the affected land or asset, is eligible to receive compensation and other entitlements. If people or households reside in, occupy or use land needed for the Project prior to a determined cut-off date (that will be disclosed to all PAPs) then they will be considered resettlement affected and eligible for compensation and entitlements.

The census survey will identify and establish the households that own assets or earn income on land required by the Project. The cut-of-date will be clearly disclosed to PAPs during consultation meetings and during one-on-one interviews for the census survey. Any persons moving into the Project area after the cut-off date will not be entitled for compensation.

The expected Project affected organizations or people (split into the two Lots) are summarized in Table 8 below:

Table 8: Eligibility for compensation for PAPs

| Project Affected People | Eligibility | Notes |
|---------------------------|---|---|
| Lot 1 (S-D OHTL) | | |
| Dzhankeldy LLC | As a leaseholder the LLC is eligible for compensation for land loss and for the servitude rights of the ROW. | Since the land which is managed by the LLC is going to be impacted and the land was legally allocated to the LLC by the Committee of Sericulture and Wool Industry Development of the Republic of Uzbekistan. |
| All herders (1-3) | As employees of Dzhankeldy LLC (even if they do not have an official employment agreement) they may be impacted by loss of employment, income or loss of livelihood (this could be as a result of loss of grazing land or livestock). | This includes also their families. |
| Herder employees | As an employee of the herder they are eligible for compensation for loss of employment (or loss of livelihood). | This includes also their families. |
| Lot 2 (N-B-M LILO) | | |
| Kokcha LLC | As a leaseholder the LLC is eligible for compensation for land loss and for the servitude rights of the ROW. | Since the land which is used by the LLC is going to be impacted and the land was legally leased to the LLC by the Committee of Sericulture and Wool Industry |

| Project Affected People | Eligibility | Notes |
|-------------------------|---|---|
| | | Development of the Republic of Uzbekistan. Proposed route for Lot 2 is located within the Project footprint of the Bash 500 MW Wind Farm to be constructed by ACWA Power. If compensation is paid to the LLC for the Bash WF there may not be a need to also compensate for the OHTL. |
| Herder | As employees of Kokcha LLC (even if he does not have an official employment agreement) he may be impacted by loss of employment, income or loss of livelihood (this could be as a result of loss of grazing land or livestock). | This herder is located and grazes livestock in Project footprint of Bash 500 MW Wind Farm. Prior to construction of the Bash WF, this herder will be resettled and compensated by ACWA. If this occurs before the Project starts construction of Lot 2 (as currently anticipated) this herder may no longer be impacted by the Project. |
| Herder employees | As employees of the herder they are eligible for compensation for loss of employment (or loss of livelihood). | This includes also their families. |

8 Entitlement matrix

Table 9 provides an entitlement matrix for different types of Project losses²⁶. The entitlement matrix also includes provisions for any unanticipated impacts arising during Project implementation. Entitlements have been stated in relation to losses as an affected households (AH) or PAP may be impacted by a number of different types of losses. NEGU will be the responsible party for compensating Project losses.

²⁶ DRAFTING NOTE: This matrix has been sent to NEGU for comment. It will be updated following NEGU's response, as relevant.

Table 9: Entitlement matrix

| Type of Loss | Type of asset | Specifications | Displaced Persons/organisations Entitled Persons | Basis for Compensation Entitlement |
|--|---|--|--|---|
| Land | Agricultural/grazing land (agricultural only if OHTL is rerouted) | Permanent for placing towers | Leaseholders/ land user with a user permit Entities responsible for managing the land (Dzhankeldy LLC and Kokcha LLC) | Monetary compensation based on the full replacement cost for the land, or another plot of equal size, value and productivity in a comparable location on the basis of "land-for land" compensation. OR Compensation for loss of land in terms of loss of income equivalent to four years of net average income of the affected crops from the affected agricultural land. This length of time is based on the Resolution #146 dated on 25.05.2011 and the "size of lost profits when excluding land from agricultural production is defined as the sum of the average annual net income from the agricultural land excluded from the agricultural production multiplied by four years for which the design will be carried out, their irrigation and the development of new lands cultivation and other work to improve soil fertility". Unaffected portions of an affected arable plot will also be compensated if the same becomes unviable after impact. Transaction cost, registration fee, related to new plot allotted, will be borne by the Project. |
| | | Temporary (laydown areas used during construction) | | The Project will ensure that any kind of temporary impact on private and public assets during project implementation for civil work purposes will be compensated by the Company based on replacement value for structures, rentals for land use, replacement value for crop and tree loss as stated above in the entitlement matrix. The Contractor will only be responsible for compensation related to unforeseen construction impacts/ damage to PAPs land that has not been compensated by the Project |
| | Either permanent or temporary | Land users (Herders and herder employees) | Compensation for loss of land in terms of loss of income (see loss of income section below) | |
| Residential land (if OHTL is rerouted) | Residential land (if OHTL is rerouted) | Permanent for placing towers | Land users who have lifelong inheritable possession or permanent possession | Monetary compensation based on the full replacement cost for the land, or another plot of equal size, value and productivity in a comparable location on the basis of "land-for land" compensation. |
| | | Temporary (loss of grazing during construction) | | |

| Type of Loss | Type of asset | Specifications | Displaced Persons/organisations Entitled Persons | Basis for Compensation Entitlement |
|--------------|--|--|--|--|
| | | | Land users (Herders 1-4) | Transportation cost will be borne by the Project. Transaction cost, registration fee, related to new plot allotted, will be borne by the Project. |
| | | Temporary (laydown areas used during construction) | | Monthly rent for the use of the land based on a negotiated agreement with the land user and the Project. |
| Servitude | Loss of servitude rights | Permanent | Entities responsible for managing the land (Dzhankeldy LLC and Kokcha LLC) | A one-off payment for the servitude rights to the land, as per determined through negotiated agreement between the leaseholder and the Project. Assets/structures that are subject to damage or demolition will be compensated (included as structural losses in unexpected costs below) |
| Structures | Residential or business structures (if OHTL is rerouted) | Permanent | Owners of the structure (irrespective of whether they own the land or have title to the structure) | Replacement cost of structures will be paid at present market value, free of depreciation and including all taxes and transfer fees. Households that need to relocate will be provided with temporary housing on the conditions of the lease agreement or rental allowance in cash for the period of land plot utilization for up to two years while the new house or building is being erected. Households that need to relocate will receive shifting allowances to move their property to the temporary and permanent relocation sites. Access to similar or better levels of infrastructure will be provided to displaced households (water, gas and electricity connections, access to social infrastructure etc. Owner will be allowed to take away all salvageable materials free of cost before start of construction. Transportation cost will be borne by the Project, or a transportation allowance will be paid. Priority participation in livelihood restoration activities. Preferential selection for Project related employment and training opportunities. |
| | Loss of place to rent | Permanent | Tenant | Replacement rental agreement Or 6 months compensation to allow PAP to re-establish the tenancy in other location. This is based on the Resolution of Cabinet Ministers of the Republic of Uzbekistan #97 which states that the Company would be obligated to |

| Type of Loss | Type of asset | Specifications | Displaced Persons/organisations Entitled Persons | Basis for Compensation Entitlement |
|--------------|--|--|---|---|
| | | | | cover up to 2 years of rental cost, or provide a temporary home for the PAP. Compensation for lost rent paid in advance. Shifting allowances to hire vehicle for transportation of the family members, goods, and property to new lease sites. Tenants without a formal notarized lease will need to show proof or evidence in order to claim compensation. |
| | Other structures (if OHTL is rerouted) | Permanent | Owners of the structure (irrespective of whether they own the land or have title to the structure) | Full replacement cost of structures will be paid at present market value, free of depreciation and including all taxes and transfer fees. Owner will be allowed to take away all salvageable materials free of cost before start of construction. |
| | Additional provision of severe impact allowance in case of physical displacement | Permanent | Physically displaced persons | Household losing structures/buildings who need to physically relocate will each be provided additional help in transportation. Priority for employment in project-related jobs, training opportunities, self-employment and wage employment assistance. |
| Income | Business disruption | Temporary loss or reduction of income as a result of the Project activities. | Affected household losing business and involved workers Entities responsible for managing the land (Dzhankeldy LLC and Kokcha LLC) | The amount of lost profit will be identified based on the estimated average monthly income in the past three years multiplied by the number of months of business interruption (up to 6 months) and provided as cash compensation, or 6 months cash compensation in case of permanent closure of business. Workers from the affected businesses will be paid for lost wages for the duration of business interruption up to 6 months. In case of informal workers working without any agreement will be paid an allowance equivalent to 3 months of the minimum wage. |
| | Business disruption | Temporary or permanent loss | Affected household losing non-titled (unregistered) business and involved workers | Affected household losing non-titled business will be paid a rehabilitation allowance equivalent to 3 months of the minimum wage. Workers from the affected non-titled businesses will be paid an allowance equivalent to 3 months of the minimum wage |

| Type of Loss | Type of asset | Specifications | Displaced Persons/organisations Entitled Persons | Basis for Compensation Entitlement |
|-----------------|--|---|--|--|
| | Livelihood / employment due to physical relocation | Permanent | Livelihood / employment due to physical relocation | Affected household losing livelihood/employment due to physical displacement will get a rehabilitation allowance equivalent to 3 months of average monthly income in case of provision of relevant grounds of such loss. |
| | Loss of grazing land and increased costs to feed animals | Permanent loss or reduction of income as a result of a reduction of usable land | Herders | <p>Compensation of the PAPs salary or minimum wage (whichever is highest) for the remaining part of the agricultural year/or contractual period whichever is higher in monetary value.</p> <p>Provision of three months' worth of feed for livestock or an allowance equivalent to three months' worth of feed.</p> <p>Priority inclusion in the Livelihood restoration activities (as relevant)</p> <p>Preferential selection for Project related employment.</p> |
| | | Temporary loss or reduction of income as a result of the Project activities. | | <p>Compensation of the PAPs salary or minimum wage (whichever is highest) for 3 months.</p> <p>Provision of one month worth of feed for livestock or an allowance equivalent to one month worth of feed.</p> <p>Priority inclusion in the Livelihood restoration activities (as relevant)</p> <p>Preferential selection for Project related employment.</p> |
| | Loss of employment/ reduced employment | Permanent loss or reduction of income as a result of a reduction of usable land | Herder employees | <p>Compensation of the PAPs salary for the remaining part of the agricultural year/or contractual period whichever is higher in monetary value..</p> <p>Priority inclusion in the Livelihood restoration activities (as relevant)</p> <p>Preferential selection for Project related employment.</p> |
| | | Temporary loss or reduction of income as a result of the Project activities. | | <p>Compensation of the PAPs salary or minimum wage (whichever is highest) for 3 months.</p> <p>Priority inclusion in the Livelihood restoration activities (as relevant)</p> <p>Preferential selection for Project related employment.</p> |
| Crops and trees | Crops (if OHTL is rerouted) | Permanent loss | Owner of crops (irrespective of land use rights) | In the case that crops are not ready to harvest, compensation for primary (and secondary crops if any) on affected land based on 1 year of production costs (inputs) plus an allowance equivalent to 1 year average net |

| Type of Loss | Type of asset | Specifications | Displaced Persons/organisations Entitled Persons | Basis for Compensation Entitlement |
|--------------|-----------------------------|----------------|---|---|
| | | | | <p>income based on the average income over the past 3 years</p> <p>An allowance equivalent to one-year average net income based on the average income over the past three years.</p> <p>Advance notice provided so that owners can harvest the crops</p> <p>Owner of the crops will be allowed to harvest free of cost prior to construction.</p> |
| | | Temporary loss | Owner of crops (irrespective of land use rights) | <p>In the case that crops are not ready to harvest, compensation for primary (and secondary crops if any) on affected land based on one year of production costs (inputs) plus an allowance equivalent to one year average net income based on the average income over the past three years.</p> <p>Advance notice provided so that owners can harvest the crops</p> <p>Construction scheduled to avoid crop harvest</p> <p>Land restoration to previous standard and use continued cultivation allowed post construction</p> <p>Duration of construction will not exceed more than one crop season at each location</p> |
| | Trees (if OHTL is rerouted) | Permanent loss | Owner of fruit trees (irrespective of land use rights) | <p>Replacement cost of productive or fruit tree sapling and annual cost of production for 3 years (the time it takes for new productive tree to grow) multiplied by four. This relates to average productive years as set out in Resolution #146 of the Cabinet Ministers and the average number of years from planting a sapling for it to reach maturity.</p> <p>In instances where there is no official data available about income then: Cash compensation will be provided at market rates to be determined by an Independent Valuator including recovery value and increase index.</p> <p>Owner of the tree will be allowed to cut the tree and keep the wood free of cost prior to construction.</p> |
| | | Permanent loss | Owner of timber trees (irrespective of land use rights) | <p>Replacement of timber trees and compensation for the marked rate of the dried wood volume,</p> <p>Owner of the tree will be allowed to cut the tree and keep the wood free of cost prior to construction.</p> |

| Type of Loss | Type of asset | Specifications | Displaced Persons/organisations Entitled Persons | Basis for Compensation Entitlement |
|---------------------------------|--|-------------------------------|---|--|
| Community structures and assets | Loss or damage to public infrastructure or utilities (i.e. roads, pipelines, transmission lines) (if OHTL is rerouted) | Permanent | Affected communities | Rehabilitation/replacement of affected structures/utilities to pre-Project state. |
| Vulnerable Households | Additional losses or impacts as a result of vulnerable status. | Either permanent or temporary | Herders and herder employees as their income and livelihood activities depend on natural resources (land resources) and they involve their family members in grazing activities, women headed households. households headed by elderly with no support and household headed by physically challenged people | A one-time in-kind provision of a food basket, including flour and oil among other basic necessities, this will be in addition to compensation for other losses, for herder and herder employee households. Rehabilitation allowance equivalent to 3 months of the minimum wage, for all vulnerable households. Priority participation in livelihood restoration activities. Preferential selection for Project related employment. |
| Unanticipated losses | Any other losses | Either permanent or temporary | All affected persons | As per the LRP principles and similar provisions in this entitlement matrix |

9 Compensation and assistance

As mentioned in section 4.1 the legal basis for valuation of land loss is provided in the following legal acts:

- Resolution of Cabinet of Ministers of the Republic of Uzbekistan dated May 25, 2011 № 146 “On compensation calculation for agricultural and forestry losses”.
- Resolution of the Cabinet of Ministers of the Republic of Uzbekistan dated November 16, 2019 No.911 “On further improving procedures for providing property rights of individuals and legal entities and procedures for removal and compensation for land plots”

The above listed regulations suggest an approach for calculation of compensation for land loss. EBRD requires that the replacement cost is paid for all Project losses. The replacement cost of land or structures is considered to include (i) fair market value (ii) transaction costs (iii) interest accrued (iv) renovation costs and (v) other payments as applicable. The replacement cost does not take into account the depreciation value of an item.

9.1 Compensation for land acquisition

In order to calculate compensation for land losses, under legal requirements, the khokimiyats of the respective districts will create a commission to determine the amount of compensation and type of compensation to be paid to the landowners, for both land acquisition and servitude. This commission is usually headed by the Deputy Khokim. After issuing a statement on land acquisition or for servitude, the local khokimiyat together with relevant organisations and departments (Land Resources and State Cadastre Department of the district, Architecture and Construction Department of the district and representatives of other competent authorities at the discretion of the khokimiyat) will start the valuation process.

Resolution of the Cabinet of Ministers of the Republic of Uzbekistan No. 146 dated 25.05.2011 “On measures to implement urban development activities and improve the procedure for allocating land plots for other non-agricultural needs”, in accordance with the Land Code and the Civil Code of the Republic of Uzbekistan, establishes the procedure for determining the size and compensation of losses to owners, users, tenants and owners of land plots, as well as losses of agricultural (pastoral) and forestry production. This will be the case for both land acquisition and servitude.

Since land belongs to State Committee on Sericulture and Wool Industry Development, all process related to land acquisition, land lease agreement and calculation of compensation should be performed with participation of the Committee

The estimation of cost of the land plot used by Uzbek citizens on the right of lifelong inheritable ownership at the time of its acquisition, is made by the Departments of Land Resources and State Cadastre of the district, according to the current prices at the time of the valuation. Specific terms of payment of compensation are established by the decision of Khokims of the district with payment of monetary compensation to be made prior to demolition.

If a project is undertaken using international investments, Resolution of CoB No.911 from 16 November 2019, allows the project to apply the international standards in the realisation of the

project. Therefore, NEGU will review compensation against EBRD requirements to ensure full replacement cost is reached and to ensure all eligible parties are compensated as per Table 8 and

Table 9 above. If necessary, the Project will bridge the difference between compensations calculations provided by government entities and replacement cost of the land (or asset) under EBRD requirements by including a “top up” so that compensation reaches replacement rates.

Considering that local legislation may not cover all PAPs, particularly illegal land users, should any PAPs be identified that are not covered by the legal requirements, they will be paid the market value, which will be determined by an independent valuer (hired by NEGU) for the land (without depreciation) plus any relevant transaction costs. The Project Developer (NEGU) will be responsible for identifying the rate and will follow the rules and standards prescribed by EBRD.

9.2 Methods of valuing affected assets

It is not expected that assets will be affected by construction of the Project, as per the proposed route. The main impact will be on permanent land loss while placing towers, as well as temporary land loss during construction works.

Under national law, valuation of houses and other structures, as well as perennial crops, pastoral and agricultural lands is in all cases made by an independent valuation company at the expense of the applicant (in this case NEGU). A valuation report is then transferred to the commission (discussed in section 9.1 above). The independent valuation companies use the national standards of property valuation. The key principle of valuation is the principle of replacement based on the relevant market data.

NEGU will ensure the applicability of proposed methods for valuing affected assets against EBRD requirements. It will also involve an independent valuer to ensure provision of an independent view and calculation of loss. The Project will bridge the difference between compensations calculations provided by government entities and replacement cost under EBRD requirements, if necessary.

9.3 Crops and trees

There were no crops or trees identified as being impacted by the proposed Project. However, should the design change and impacts on crops and trees be identified, they will be compensated as follows:

Crops – PAPs will be provided with seeds to replace any lost crops and an allowance equivalent to one-year average net income obtained from the crops, based on the average income received over the past three years. The owner of the crops will also be allowed to harvest the crops free of cost prior to construction.

Wood trees – A replacement tree or the cost of a timber tree sapling will be provided and compensation for the marked rate of the dried volume of wood. The owner of the tree will be allowed to cut the tree and keep the wood prior to construction.

Productive trees - Replacement tree or the cost of a productive tree sapling and annual cost of production for three years (the time it takes for new productive tree to grow) multiplied by four. As with wood trees, the owner of the tree will be allowed to cut the tree and keep the wood prior to construction.

9.4 Incomes

There will be three different types of entities that will lose income. These include the LLCs, the herders and the herder employees. Should any other type of income loss to a business it will be

compensated as per the LLCs and to individual PAP it will be compensated as per herder employees.

LLCs - Resolution of Cabinet Ministers No. 146 requires that the amount of lost profit will be identified based on the estimated average monthly income in the past three years multiplied by the number of months of business interruption and provided as cash compensation.

Herders (permanent impacts) – The amount of compensation paid will be equivalent to the PAPs salary or the Uzbekistan minimum wage (whichever is highest) for six months or more to be determined by NEGU depending on the level of impact. In addition, herders may incur costs to feed animals on less area of land, or land that is less productive. Therefore, they will be provided three months' worth of feed for livestock or an allowance equivalent to three months' worth of feed. They will also be given priority inclusion in the livelihood restoration activities (as relevant).

Herders (temporary impacts) – Compensation will be provided at the rate of the PAPs salary or minimum wage (whichever is highest) for three months. They will also be provided one month worth of feed for livestock or an allowance equivalent to one month worth of feed and priority inclusion in the livelihood restoration activities (as relevant)

Herder employees – The amount of compensation paid will be equivalent to the PAPs salary or minimum wage (whichever is highest) for six months or more to be determined by NEGU depending on the level of impact. They will also receive priority inclusion in the livelihood restoration activities (as relevant).

9.5 Compensation for servitude

According to the Resolutions of the Cabinet of Ministries of the Republic of Uzbekistan No 146 and 911. Compensation for servitude will be determined the same way as for land acquisition; however, it will be a separate payment. NEGU will again make sure the cost identified by government authorities meets full replacement costs as per EBRD requirements.

Any losses/damages while obtaining servitude rights for land whether it will be for permanent or temporary land loss should be compensated. It is not expected that any assets, including crops and trees will be impacted.

9.6 Vulnerable groups

Additional support will be provided to vulnerable households in the form of a one-time in-kind provision of a food basket, including flour and oil among other basic necessities, this will be in addition to compensation for other losses.

Herders and herder employees, as their income and livelihood activities depend on natural resources (land resources) and they involve their family members in grazing activities, will all be considered to be vulnerable.

Vulnerable PAPs will also receive priority participation in livelihood restoration activities and preferential selection for Project related employment (where relevant).

9.7 Allowances

Herders may incur extra costs as a result of land use restrictions. These could occur as a result of having to move their livestock to an area that does not have comparable/sufficient foliage. Therefore, herders would need to pay to supplement the feed of the animals. Therefore, one-

month worth of feed for livestock or an allowance equivalent to one-month worth of feed will be provided to herders.

Where there are residential or business losses and relocation is required (this is not expected as part of the Project, unless the routing of the OHTL changes), the Project will cover the costs of transportation for those PAPs that require relocation.

10 Implementation schedule

An implementation schedule will be included in the LRP. It will be detailed and time bound and include all key resettlement activities. In addition to the activities described in section 6.1, the following content should be included in the implementation schedule:

- Community consultations
- LRP disclosure
- Set up and ongoing use of the grievance mechanism
- Detailed design completion
- Site demarcation of affected lands
- Inventory of affected land (and assets)
- Compensation assessment by independent valuer
- Completion of LRP
- Approval of LRP by EBDB
- Payment of compensation and provision of entitlements
- Livelihood restoration activities
- Start of preliminary works
- Start of main construction works
- Internal and external monitoring

No implementation activities have been started at the time of preparing this LARF, as resettlement impacts have not yet been confirmed through the completion of Project designs.

11 Livelihood restoration activities

Livelihood restoration activities will be identified to assist PAPs to restore, if not improve their livelihoods to pre-Project levels. The details of the activities will be identified following confirmation of the Project impacts and will be commensurate with the identified impacts. The activities will be developed in consultation with the PAPs. Specific measures will be identified for vulnerable households, as these households may find it more difficult to recover their livelihoods following the implementation of the Project.

One possible method of livelihood restoration is to identify training courses. Training courses would be identified during the implementation of the LRP through a needs assessment of the participants.

An overall budget for compensation, assistance will be prepared and included in the LRP. The budget will be the responsibility of NEGU.

12 Organizational arrangements

To ensure the effective functioning of the LRP it is important to determine responsible parties and allocate responsibilities between them. As of the writing of this LARF, there are six main parties:

- The ESIA Consultant team – Juru Energy;

- Project Implementing Organisation – NEGU;
- The Lender – EBRD.
- State Committee on Sericulture and Wool Industry Development – Landowner;
- Dzhankeldy LLC – Land leaseholder; and
- Kokcha LLC²⁷ - Land leaseholder

The responsibilities for each key party are discussed in the sections below.

12.1 Key responsible parties

12.1.1 Juru Energy

JE will be responsible for the preparation of LARF (this document) on behalf of NEGU. JE's responsibilities include:

- Assess the current situation;
- Identify main PAPs as per suggested route for the OHTL;
- Identify main legislation principles for land acquisition and compensation process; and
- Identify key stakeholders that should be consulted during the LRP stage.

12.1.2 NEGU

NEGU will take over realisation of land acquisition and livelihood restoration process following the completion of the ESIA phase (some of the responsibilities listed below may be passed on to the Main Contractor). It will be ultimately responsible for resettlement planning and overseeing the preparation of the LRP (by a competent third-party consultant). NEGU's responsibilities are outlined below:

- Oversee the development of the LRP (using a qualified third-party consultant);
- Conduct meaningful consultations with PAPs and determine their needs and requirements for additional support;
- Negotiate with landowners and agree on lease conditions for permanent and temporary land acquisition;
- Negotiate with herders and agree on compensation arrangements;
- Arrange hiring an independent valuer to evaluate the land and other constructional impact to PAPs;
- Disclose the compensation calculation with PAPs;
- Sign Land Lease Agreement with the landowners and herders;
- Support the grievance mechanism throughout the LRP process;
- Provide payment to PAPs before the commencement of constructional works; and
- Restore surrounding land after placing towers and completion of construction works.

12.1.3 EBRD

EBRD has specific requirements for involuntary resettlement under its loan modalities. It also has disclosure requirements that a Project must comply with. EBRD will also monitor the implementation of involuntary resettlement per its requirements. EBRD's responsibilities are as follows.

- Review of provided reports;
- Disclosure of final reports on EBRD's website (as relevant); and
- Periodically review implementation of the Project.

²⁷ Subject to the further implementation process and established timeline for Project realisation by NEGU.

12.1.4 State Committee on Sericulture and Wool Industry Development

As a main landowner and government entity, that allocates pasture lands to its subordinate organisations such as the LLCs the State Committee will take on the following responsibilities:

- Provide alternative land/re-define land lease agreement for affected LLC if required;
- Support NEGU in providing information on activities of the Committee and its subordinate structures as required to assess the level of impact from Project construction and land acquisition; and
- Support NEGU in communication with local LLCs and participate in negotiations for Land Lease Agreements.

12.1.5 Dzhankeldy and Kokcha LLC

As the two main land users, the LLCs will take on the following responsibilities:

- Provide information on assets belonging to the LLC along the proposed route of the OHTL;
- Provide information about herders who work for LLCs as well as number of livestock and the sizes of grazing areas;
- Participate in consultation for the preparation of the LRP;
- Participate in the inventory survey; and
- Sign the Land Lease Agreement with NEGU.

13 Time frame

Table 10 provides an overview of the Project timeframes. The preparation and implementation of the LARF and the subsequent LRP is expected to occur during the Pre-mobilization phase, following financial close, but prior to the commencement of construction. Therefore, it is expected that this work will be undertaken in 2023.

Table 10: Current anticipated development schedule (February 2022)

| Activity | Date |
|--|-------------------------------------|
| Project Categorisation | August 2021 (completed) |
| Scoping and route definition | October 2021 (completed) |
| Consultation on draft ESIA | January 2022 (completed) |
| Finalization of the Submission of draft ESIA | February 2022 |
| EBRD 120-day disclosure period | March 2022 to June 2022 |
| Finalise ESIA (including public consultation comments and ongoing studies) | June 2022 |
| EBRD Board of Director's consideration and project signing | July 2022 |
| Financial close | Q3 2022 (Immediately after signing) |
| Pre-mobilisation (finalisation of route corridor, tower micro-siting, planning and design) | Q4 2022 – Q1 2023 |

| Activity | Date |
|--------------------|--------------------------|
| Construction Start | Q1 2023 |
| Construction End | Q2 2024 |
| Expected Lifetime | Approx. 30 years or more |

As per requirements of PR5, as well as national legislation, all PAPs will be compensated before commencement of any site mobilisation works at each Project location.

The Project timing will also take into account of the neighbouring Bash 500 MW Wind Farm livelihood restoration schedule noting that the PAPs for Lot 2 will be impacted by both projects.

14 Disclosure of information and consultations

Stakeholder engagement up to the writing of this LARF has been undertaken for the scoping report and the preparation of the ESIA report (see the Stakeholder Engagement Plan (SEP) Volume V for further details). During these meetings and discussions, the potential land acquisition impacts have been discussed as described in the sections below. Consultation on affected land cannot be completed until the final design of the Project has been determined and will be updated in the SEP and elaborated in an LRP at the appropriate time.

14.1 Consultations

As a part of the ESIA preparation for S-D OHTL, JE interviewed herders along proposed OHTL route. Initial identification and interviews with herders were conducted on October 12-16, 2021 (at the Scoping stage) and surveys were conducted on November 16-18, 2021, as well as one phone interview on November 22, 2021. The aim of interviews and surveys was to determine the type of land use and the activities undertaken on the land for each herder.

JE has attempted to meet with the local LLCs to conduct consultations but have not been able to meet at the time of writing this LARF. NEGU will need to follow up with the LLCs once it takes over implementation of the livelihood restoration.

Overall, three herders were identified along Lot 1 and one herder along Lot 2. All identified herders graze livestock close to the proposed OHTL route and own assets (mainly houses and stables).

14.2 Stakeholders

Key stakeholders for the land acquisition and livelihood restoration impacts include:

- State Committee on Sericulture and Wool Industry Development;
- Dzhankeldy LLC;
- Kokcha LLC²⁸
- Herders 1-4;
- Herder employees;
- Local community leaders; and

²⁸ Subject to the further implementation process and established timeline for Project realisation by NEGU.

- NGOs or other interested parties (if relevant).

14.3 Future engagement with PAPs

Preparation of the LRP will require consultation with all of the identified stakeholders. It will also require a socioeconomic and census survey (which can be undertaken simultaneously), and disclosure to the PAPs of a cut-off date for compensation and disclosure of the grievance mechanism. This future engagement will be defined in the LRP.

15 Grievance mechanism

EBRD PR10 requires its Clients to establish an effective grievance mechanism in order to keep communication with stakeholders, i.e., be aware of their concerns, and provide responses to their inquiries. At the Scoping and ESIA stages of the Project, JE will be responsible of receipt of grievances with assistance from NEGU. However, following the ESIA phase the responsibility for grievance receipt and redress will be entirely the responsibility of NEGU. This includes general community grievances and grievances related to involuntary resettlement activities.

15.1 Grievance reporting and resolution

Grievances can be raised through the following methods:

- Directly to Project staff during meetings, or Project site visits,
- Via phone calls
- In written form (text messages via email, mobile applications, written requests etc).

Contact details for each of these methods are included in the next section (section **Error! Reference source not found.**).

JE has prepared a grievance form to be used when a grievance is received. The grievance form is provided in Annex C. The grievance form was prepared based on location, language preferences as well as communication opportunities of identified stakeholders.

15.2 Responsibilities

15.2.1 Juru Energy

During the scoping and ESIA phase, stakeholder engagement is being undertaken by JE. Therefore, JE is acting as the main focus point for PAPs to raise grievances from local communities. Any grievances raised will be recorded in the grievance form and logged in the grievance log. NEGU will assist in the resolution of grievances and JE and/or NEGU will provide a response to the grievance.

15.2.2 NEGU

NEGU will identify sufficient staff members to undertake land acquisition and livelihood restoration engagement activities as required in this LARF. These staff members will start once identified and assist JE in engagement activities. It will take over engagement activities following the ESIA phase. It is expected that a Community Liaison Officer will be identified by NEGU. This person will be the main point of contact between the Project and the local communities.

15.3 Contact details

Contact details of for JE representatives that will be responsible for receipt of grievances during the EISA stage are provided in Table 11.

Table 11: Contact details:

| Company | Contact Details |
|---|---|
| Juru Energy Viktoriya Filatova – Environmental Consultant | Email: v.filtova@juruenergy.com , sarimay_ohtl_esia@juruenergy.com Work: +998 712020440 |
| Juru Energy Zilola Kazakova – Senior Social Consultant | Email: z.kazakova@juruenergy.com sarimay_ohtl_esia@juruenergy.com Work: +998 712020440 |

The current point of contact for NEGU is included in Table 12.

Table 12: NEGU Contact details

| Company | Contact Details |
|--|---|
| NEGU NEGU Complaints line | Telephone +998 7) 236-68-65 Email: info@uzbekistonmet.uz Address: Tashkent city, 100084, Yunusabad district, Osiye street, 42nd house. Web site: uzbekistonmet.uz |
| NEGU Islombek Saparmatov – NEGU contact person | Email: sarimay.jankeldi@gmail.com Telephone +998 71 236-68-08 |

15.4 Confidentiality and anonymity

The grievance mechanism will keep strict confidentiality of data, including the personal information of all applicants. At the stage of grievance receipt/registration the complainant will be informed that they can submit a grievance anonymously. Complainants will be informed that some grievances may not be able to be responded to if they are made anonymously.

15.5 Grievance resolution options and response

The approach taken to resolve grievances will depend on the nature, frequency of occurrence and the number of grievances. Upon the receipt of a grievance, by any means of communication, it will be entered into the grievance log to ensure that all raised concerns/inquiries are investigated and addressed. The grievance log is provided in Annex D.

After receipt and registration of a grievance, an applicant will receive written notification that includes a proposed timeline for the investigation depending on the request and preliminary time of receipt of a response.

Responses will be provided in a language that is suitable for the complainant, i.e., Uzbek, Russian or Kazakh. JE will be responsible for the receipt and monitoring of grievances during the ESIA phase of the Project and NEGU will be responsible following the ESIA phase. Resolution of the grievance will be communicated to the applicant in written form. In cases where the complainant cannot receive a written response, the complainant will be contacted via phone call and informed of the results of their grievance. Table 13 provides the timeframes for response to grievances.

Table 13: Grievance Process and Timeline

| Receipt and registration of grievance | - |
|--|--|
| Providing acknowledgement of grievance receipt to complainant | Maximum 2 days after submission of grievance |
| Assessment/investigation of received grievance | Maximum 2 weeks after submission of grievance |
| Providing complainant with a response | Maximum 2 weeks after submission of grievance |
| Reassessment of grievance in case if complainant is not satisfied with previous provide response | Maximum 2 weeks after notification of dissatisfaction by the complainant |
| | |

Where complex grievances, or other factors are extending the investigation time, the complainant will be informed of this delay and advised of an updated expected timeline for a response.

Figure 15 provides a flow chart of how a grievance can be filed by a PAP.

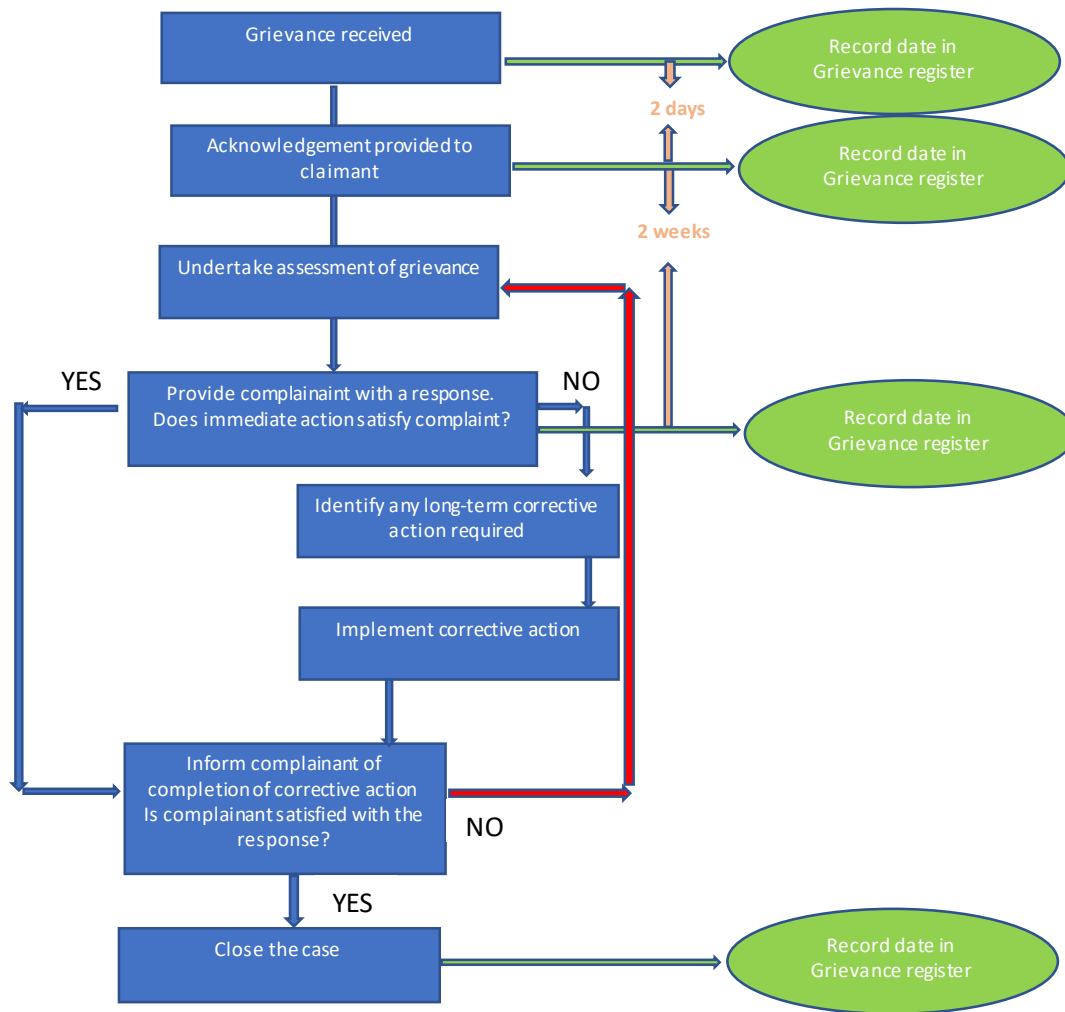

Figure 15: Grievance mechanism flow chart

In cases, when a complainant is not satisfied with proposed solution/response to the grievance, they have the right to take other legal action to resolve the grievance.

16 Monitoring and reporting

Monitoring will enable the Project to establish continuous communication with PAPs through the grievance mechanism, assess the process of LRP implementation, and ensure the implementation of actions required under national law and EBRD requirements while land acquisition and restoration of livelihoods are being achieved.

The livelihood restoration process will be monitored by NEGU (or the Main Contractor). There are various activities that require monitoring and reporting as part of this LARF. They are discussed in the following sections.

16.1 Resettlement reporting

Current LARF will be disclosed as part of the ESIA documentation. Following preparation of the LRP, regular monthly internal reporting will be prepared during LRP implementation to disclose livelihood restoration progress. Main indicators will include, but will be not limited to, the following:

- Consultations with stakeholders and PAPs. Outcomes of consultations (response letters, MoMs etc);
- Compensation paid;
- Livelihood restoration activities undertaken; and
- Grievances received.

16.2 Resettlement completion report

Following the completion of LRP implementation an LRP completion report will be prepared which will disclose the process undertaken, any lessons learned and the final outcomes of the livelihood restoration activities. As the level of impact is not significant, it is expected that an external completion audit will not be necessary.

16.3 Grievance logging

Tracking and logging for each grievance should be recorded in a grievance log (Annex D). Each grievance will be given an individual identification number and followed through by recording details and timing of its resolution and close-out.

17 Implementation costs

The final budget intended for compensation, monitoring as well as the type of additional support to be provided to PAPs will be included in LRP.

Annex A: Resettlement Plan Table of Contents

| Section | Overview of content |
|-----------------------------|--|
| Introduction ²⁹ | <ul style="list-style-type: none"> • Purpose, scope and content of the plan • How the plan was prepared and approved and by whom |
| Project description | <ul style="list-style-type: none"> • General description of the project and description of the project components and activities that will require land acquisition and cause physical/economic displacement. |
| Project impacts | <ul style="list-style-type: none"> • Expected project impacts/losses associated with the project components/phases covered by the plan • Explanation of all activities and alternatives considered to avoid or minimise displacement |
| Legal framework | <ul style="list-style-type: none"> • National legal framework (expropriation, land tenure) and provision of resettlement/livelihood restoration assistance) • EBRD requirements • Gap analysis between national legislation and EBRD requirements and measures to bridge any gaps between them • If necessary, a more detailed gap analysis addressing the specific legal requirements that pertain to the displacement caused by project components in question. |
| Affected people and assets | <ul style="list-style-type: none"> • Results of the socio-economic survey and any other tools used, such as focus groups, covering, for example: <ul style="list-style-type: none"> ○ People/households who will be physically displaced and their land ownership status ○ People/households/businesses who will be economically displaced and their land ownership status ○ Standard characteristics of displaced people/households businesses and baseline information ○ Information on vulnerable groups ○ Social networks and social support systems, and how they will be affected by the project • Description of affected assets, including natural resources, public infrastructure and services |
| Eligibility | <ul style="list-style-type: none"> • Description and results of the census • Cut-off date for eligibility • Eligibility of categories of displaced persons for compensation and other resettlement assistance |
| Entitlements matrix | <ul style="list-style-type: none"> • Entitlements matrix addressing categories of losses and entitlements pertaining to the project components/phases in question |
| Compensation and assistance | <ul style="list-style-type: none"> • Description of the methodology for valuing losses to determine their replacement cost • Description of compensation and assistance measures • Description of process for executing compensation and assistance • Description of organised resettlement programme (selection of locations, design of housing, planned infrastructure, improvements for host community), if applicable |

²⁹ Adapted from EBRD Resettlement Guidance for Good Practice (undated)

| Section | Overview of content |
|---|--|
| Organisational arrangements | <ul style="list-style-type: none"> • Procedures for the delivery of entitlements and the roles and responsibilities of all involved agencies/organisations (client, authorities, various service providers), including coordination arrangements |
| Time frame | <ul style="list-style-type: none"> • Implementation time frame covering all activities from preparation of the plan through implementation, including monitoring and evaluation |
| Disclosure of information and consultations | <ul style="list-style-type: none"> • Description of engagement activities undertaken as part of developing the plan, its finalisation and approval • Summary of the views expressed and how these were taken into account in preparing the plan • Description of planned stakeholder engagement during implementation |
| Grievance mechanism | <ul style="list-style-type: none"> • Description of grievance mechanism with contact details of those responsible for grievances for the project component/phase in question |
| Monitoring and reporting | <ul style="list-style-type: none"> • Description of the internal and external monitoring and evaluation arrangements • Monitoring indicators to measure inputs, outputs, and outcomes for resettlement/livelihood restoration activities • Reporting on implementation of the plan |
| Implementation costs | <ul style="list-style-type: none"> • Tables presenting expected costs for all resettlement activities and sources of funds |

Annex B: Project grievance form

| Ref № | | |
|-------|---|--|
| 1 | Name (indicate if complainant preferred to be anonymous) | Full name (if applicable): Gender: Age: Address (if applicable): Occupation (if applicable): I wish my identity not to be disclosed: ____ |
| 2 | Contact information (need to specify the way to get back to complainant) | Mob phone: Fax: Email: Other (specify): |
| 3 | How compliant/feedback/request was received and by whom | Phone call: Text/WhatsApp applications: Verbal communication: Letter/Email: Receiver's name: |
| 4 | Purpose of contact | Make a compliant: Give a feedback: Request information: Other (specify): |
| | Date application was received | Date: Time: |

| | | |
|---|---|---|
| | | |
| 5 | Text of applicant's message | |
| 6 | Response message (after receipt of application) | <p>Dear _____</p> <p>We confirm that we have received your application. We would like to inform you that your application is under review. You will receive the response within two weeks of submission of the application.</p> <p>We also would like to inform you that you will get written response for the issues you have raised in your request. We will keep you updated. Thank you for your understanding.</p> <p><i>This message was delivered to the applicant by _____ on _____ at ___ via _____</i></p> |
| 7 | Summary of the response provided to the applicant | |
| 8 | Follow up actions required: | |
| 9 | Date the application was closed | Date: |

The message was addressed by _____

Date/Month/Year _____

The response was delivered by _____

Date/Month/Year _____

Signature and stamp _____

Annex C: Project grievance log

| Application ID | Received Date | Name of applicant, if applicable | Contact Details if applicable | Preferred Language | Requested Anonymity | Summary of application | Responsible Person for responding | Actions to be undertaken | Due date | Results of the Actions | Closing date | Evidence (if applicable) |
|----------------|---------------|----------------------------------|-------------------------------|--------------------|---------------------|------------------------|-----------------------------------|--------------------------|----------|------------------------|--------------|--------------------------|
| | | | | | | | | | | | | |
| | | | | | | | | | | | | |
| | | | | | | | | | | | | |
| | | | | | | | | | | | | |
| | | | | | | | | | | | | |