

---

**Sarimay-Dzhankeldy  
Transmission**

**Environmental & Social Impact  
Assessment (ESIA):**

**Volume IV – Framework  
Environmental & Social  
Management Plan (ESMP)**

---

**CLIENT: NEGU**

Date: March 2022

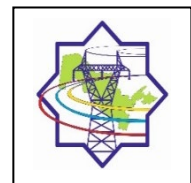

**Juru Energy Ltd.**

Suite 1, One George Yard, London

United Kingdom, EC3V 9DF

T: +44 207 859 4028

## Document Information

<b>Project Name</b>	Sarimay-Dzhankeldy Transmission
<b>Document Title</b>	Environmental and Social Management Plan
<b>Juru Energy's Project Reference</b>	UZB _Sarimay-Dzhankeldy
<b>Client</b>	NEGU
<b>JE Project Manager</b>	Nicola Davies
<b>JE Project Director</b>	Jushkinbek Ismailov

## Document Control

Version	Version Date	Description	Author	Reviewer	Approver
1.0	22 December 2021	ESMP draft for NEGU review	Various	Marianne Lupton	Nicola Davies
2.0	25 February 2022	Final Draft for disclosure	Various	Marianne Lupton	Nicola Davies
3.0	18 March 2022	Final for disclosure	Various	Marianne Lupton	Nicola Davies

### Disclaimer:

The Environmental and Social Assessment Report (the "Report") has been prepared by Juru Energy. Whilst the information contained in the report is reflective of the current status, Juru Energy make no representation or warranty, express or implied, as to the accuracy of the information set forth in this report and accept no liability for any information that may have been misstated or omitted.

This report has been prepared exclusively for NEGU. NEGU makes no representation or warranty, express or implied, as to the accuracy or completeness of the information set forth in this report. NEGU has not independently verified any of the information contained in this report and accept no liability whatsoever for any information, misstatement or omission contained therein. The report remains NEGU's property.

## Contents

Document Information	2
Document Control	2
Contents	3
Table of Figures	4
Table of Tables	4
List of Abbreviations	6
1 Introduction	8
1.1 Background	8
1.2 Scope of the ESMP	8
1.3 The objective of the ESMP	9
2 Project overview	11
2.1 Introduction	11
2.2 Project Location	12
2.3 Project receptors	16
2.4 Land requirements	18
2.5 Project components	18
2.6 Development and construction activities	18
2.7 Project schedule	20
3 Regulatory Framework	21
3.1 Key requirements	21
3.2 Permits and approvals	21
3.3 National regulatory framework	22
3.3.1 Law on Environmental Control, 2013 as Amended in 2021	22
3.3.2 Environment	23
3.4 Land Law	23
3.5 Labour and Employment	24
3.6 Cultural heritage	26
3.7 National norms and standards for transmission projects	26
3.8 EBRD Requirements	27
4 Organisational framework	29
4.1 Overview	29
4.2 EPC Contractor selection	29
4.3 Project implementation structure	29
4.4 Engineering, Procurement and Construction (EPC) Contractor	30
4.5 Subcontractors	31
4.6 Lender	36

4.7	SCEEP	36
5	Environmental and Social Management	37
5.1	Environmental and social management system (ESMS)	37
5.2	Environmental and Social Management Plans	39
6	Mitigation and Management Requirements	40
6.1	Introduction	40
6.2	Mitigation and Management Requirements - Design phase	41
6.3	Mitigation and Management Requirements - Pre-mobilisation phase	43
6.4	Mitigation and Management Requirements - Construction	49
6.5	Mitigation and Management Requirements – Operation phase	71
7	Monitoring and reporting	73
8	Stakeholder Engagement	75
9	Grievance mechanism	76
	Annex A: Project Grievance Form	77
	Annex B: Outline for key environmental management plans	79
	Annex C: Outline for Social management plans	81
	Annex D: Labour reporting templates	81

## Table of Figures

Figure 1: Overview of the location of the Project Lots in the wider region .....	13
Figure 2: Project Location 500kV Sarimay- Dzhankeldy OHTL (Lot 1).....	14
Figure 3: Project Location 500KV Navoi TPP - Bash SS - Muruntau SS LILO OHTL Connection (Lot 2) .	15
Figure 4 Simplified schematic of the proposed Project at wider 500kV transmission network.....	16
Figure 5: Receptors within the direct AOI Lot 1.....	17
Figure 6: Receptors within the direct AOI Lot 2.....	17
Figure 7: Stages in the project cycle .....	19
Figure 8: Components of an ESMS.....	39

## Table of Tables

Table 1 Summary of topics addressed in the ESMP.....	9
Table 2: Summary of OHTL characteristics .....	11
Table 3: Current anticipated development schedule .....	20
Table 4: Required permits and licenses .....	21
Table 5: Labour Conventions ratified by Uzbekistan .....	25
Table 6: Conventions relevant to the Project that Uzbekistan has ratified.....	28
Table 7: EPC Contractor E&S responsibilities (per Lot).....	32
Table 8: Summary of Project management plans and sub-plans, .....	40
Table 9: Mitigation and management requirements – design phase.....	41
Table 10: Mitigation and management requirements – pre-financing / pre-mobilisation (any mobilization to site except pre-construction survey work).....	43

Table 11: Mitigation and management requirements – construction ..... 49  
Table 12: Mitigation and management requirements – operation phase ..... 71  
Table 13: Monitoring and reporting obligations -construction ..... 73  
Table 14: Monitoring and reporting obligations - operation..... 74

## List of Abbreviations

Acronym	Definition
A&E	Accident and emergency
AIS	Air-Insulated Switchgear
AOI	Area of Influence
BAP	Biodiversity Action Plan
BMP	Biodiversity Management Plan
CC	Civil Code
C-ESMP	Construction Environmental and Social Management Plan
CHS	Community Health and Safety
CLO	Community Liaison Officer
COD	Commercial Operation Date
D-ESMP	Decommissioning Environmental and Social Management Plan
E&S	Environmental and Social
EBRD	European Bank for Reconstruction and Development
EHS	Environment, Health and Safety
EIA	Environmental Impact Assessment
EPC	Engineering, Procurement and Construction
EPRP	Emergency Preparedness and Response Plan
ESAP	Environmental and Social Action Plan
ESIA	Environmental and Social Impact Assessment
ESMP	Environmental and Social Management Plan
ESMS	Environmental and Social Management System
ESP	Environmental and Social Policy
EU	European Union
FC	Financial Close
GBV/SEA	Gender Based Violence/Sexual Exploitation and Abuse
GBVH	Gender-Based Violence & Harassment
GIP	Good International Practice
GM	Grievance mechanism
H&S	Health and Safety
HPZ	Health Protection Zone
HR	Human Resources
HRRP	Habitat Removal and Reinstatement Plan
HSES	Health Safety Environment and Social
IBA	Important Bird Area
IFC	International Finance Corporation
ILO	International Labour Organisation
IUCN	International Union for Conservation of Nature
JE	Juru Energy
LC	Land Code
LILO	Line-in Line out
LRP	Livelihood Restoration Plan
MCC	Makhalla Community Council
MSDS	Material Safety Data Sheets
N-B-M	Navoi – Bash - Muruntau
NEGU	National Electric Grid of Uzbekistan
NSR	Noise Sensitive Receptors
NTP	Notice to Proceed
NTS	Non-Technical Summary

<b>Acronym</b>	<b>Definition</b>
O&M	Operations and Maintenance
O-ESMP	Operations Environmental and Social Management Plan
OHS	Occupational Health and Safety
OHTL	Overhead Transmission Line
PIT	Project Implementation Team
PPE	Personal Protective Equipment
PR	Performance Requirement
ROW	Right of Way
SanPiN	Sanitary Regulations and Norms of Uzbekistan
SCEEP	State Committee for Ecology and Environmental Protection of the Republic of Uzbekistan
SCRP	Site Clearance and Rehabilitation Plan
S-D	Sarimay- Dzhankeldy
SEE	State Environmental Expertise
SEFG	Southern even-fingered Gecko
SEP	Stakeholder Engagement Plan
SS	Substation
SWMP	Solid Waste Management Plan
SwS	Switching Station
TPP	Thermal Power Plant
UNCCD	United Nations Convention to Combat Desertification
UNESCO	United Nations Educational, Scientific and Cultural Organization
UNFCCC	United Nations Framework Convention on Climate Change
VCC	Village Community Council
WBG	World Bank Group

# 1 Introduction

## 1.1 Background

The European Bank for Reconstruction and Development (the “EBRD” or the “Bank”) is considering providing loan to finance the construction of a Sarimay- Dzhankeldy overhead transmission line project (S-D OHTL or the “Project”).

The Project's main purpose is to facilitate the evacuation to the national power grid of the electricity generated by renewable energy power plants under development in Bukhara and Navoi. Implementation of the project will also significantly improve the transmission network's reliability, efficiency, stability, and quality and security of the electricity supply.

EBRD PR1, Appendix 2: (para 24) makes specific reference to “Construction of high voltage overhead electrical power lines” as a project with the potential to generate significant adverse E&S impacts. Based on Appendix A and the project scoping report, the Project is categorised as Category “A”. Category A projects require a comprehensive Environmental and Social Impact Assessment (ESIA) and review of associated documents, followed by public disclosure of key documents for a minimum period of 120 days. This requirement aligns with the European Union (EU) EIA Directive requirements for Annex I projects.

The EBRD has appointed Juru Energy Ltd. (JE) to perform the ESIA for the Project following EBRD Environmental and Social Policy 2019 (ESP 2019) and supporting Performance Requirements (PRs) including preparation of a framework Environmental and Social Management Plan (ESMP) (this document).

According to the list of activities subject to state ecological expertise, which is established by the Uzbek Resolution of Cabinet of Ministers No. 541 “On further improvement of the environmental impact assessment mechanism” (2020), power transmission lines are categorised depending on the level of impact on the environment. Based on this classification this Project is categorised as Category I under EIA requirements in Uzbekistan. The two Lots will be required to undergo a separate national environmental impact assessment (EIA) process, which a third-party consultant will perform.

## 1.2 Scope of the ESMP

This document presents the Environmental and Social Management Plan (ESMP) for the Project. This ESMP collates all the mitigation measures identified in the individual assessment chapters of Volume II – ESIA and presents the framework for implementation. Where appropriate this ESMP also elaborates on the identified measures to provide minimum standards, monitoring requirements and key performance indicators for completion.

This ESMP covers the Project and Associated Facilities (as defined in Chapter 2) and covers the design, procurement, construction, operation and decommissioning phase of the works. The framework ESMP is developed to align with the environmental and social (E&S) requirements outlined in Chapter 3 including national regulations and standards and the requirements of EBRD Environmental and Social Policy 2019, including the environmental, health and safety guidance of the World Bank Group.

E&S aspects relevant to the project and assessed in the ESIA are summarised in Table 1. Specific obligations for these topics are explained in the ESIA and summarised in Chapter 5.



The framework ESMP applies to JSC NEGU, the EPC Contractor (to be determined), and all third-party subcontractors working on the Project.

Table 1 Summary of topics addressed in the ESMP

Environment	Social (including labour)
<ul style="list-style-type: none"> <li>● Climate resilience</li> <li>● Supply chain (construction)</li> <li>● Air quality - dust/fugitive (construction and decommissioning)</li> <li>● Noise (construction and decommissioning)</li> <li>● Site clearance, including habitat clearance (construction and decommissioning))</li> <li>● Hazardous material handling (construction, operation and decommissioning))</li> <li>● Waste (including hazardous waste) (construction, operation and decommissioning))</li> <li>● Wastewater discharges (construction, and decommissioning)</li> <li>● Water use and water efficiency (construction and operation and decommissioning)</li> <li>● Traffic and transportation (construction and decommissioning)</li> <li>● Pollution prevention (e.g., discharges to groundwater or land) (construction and decommissioning)</li> </ul>	<ul style="list-style-type: none"> <li>● Employment (including local content policy) (construction, operation and decommissioning)</li> <li>● Labour welfare (including the welfare of sub-contractors, casual workers and migrant workers) (construction, operation and decommissioning)</li> <li>● Supply chain management (construction)</li> <li>● Occupational health and safety (construction, operation and decommissioning)</li> <li>● Community health and safety specifically traffic safety, GBVH, communicable diseases) (construction, operation and decommissioning)</li> <li>● Security and security force management (construction and decommissioning)</li> <li>● Emergency preparedness (construction, operation and decommissioning)</li> <li>● Accommodation management (as applicable) following IFC / EBRD guidance note: Accommodation: Processes and Standards (Guidance Note by IFC and EBRD, 2009 (construction)</li> </ul>

### 1.3 The objective of the ESMP

This objective of this environmental and social management (ESMP) is to provide a framework to safeguard the environment and community against activity which may cause harm or nuisance as identified during the EISA process. The ESMP includes the following:

- Outline of the requirements for an environment and social management system (ESMS) aligned with EBRD PR1 to address impacts on sensitive receptors and related potential E&S impacts due to Project activities as identified in the ESIA including requirements for:
  - Key staffing and responsibility
  - organisation and responsibilities
  - training and awareness
  - emergency procedures and response.
  - record keeping; and
  - performance monitoring, reporting and auditing.
- Establish objectives for the ESMS

- Define mitigation measures to reduce or reverse adverse impacts and enhancement measures that increase or distribute more equitably positive impact
- Define monitoring activities for the construction and operation phases along with implementation arrangements that detail responsibility, schedule targets, key indicators and budget needs

The ESMP is structured as follows:

- Chapter 1: Project overview
- Chapter 2: Regulatory framework
- Chapter 3: Organisational framework
- Chapter 4: Environmental and social management requirements
- Chapter 5: Mitigation and management requirements
- Chapter 6: Monitoring and reporting
- Chapter 7: Stakeholder engagement
- Chapter 8: Grievance mechanism
- Chapter 9: Budget

## 2 Project overview

### 2.1 Introduction

The Project is split into two lots:

- Lot 1 - 500 kV Sarimay- Dzhankeldy OHTL (S-D OHLT) - approximately 127 km OHTL located in the southwestern part of the Kyzyl-Kum Desert.
- Lot 2 – 500 kV Navoi TPP – Bash SS - Muruntau SS LILO OHTL (N-B-M LILO) - approximately 10 km in length, split between two 5 km sections for a LILO connection from the 500kV Bash SS (under development) to the 500 kV Muruntau-Navoi OHTL (under construction).

Related activities required to support the main OHTL work include the following:

- end-user works at the Sarimay SS (Lot 1)
- end-user works at the Dzhankeldy SS (Lot 1)
- end-user works at the Bash SwS (Lot 2)
- establish 60m ROW under the OHTL (including the provision of any related livelihood compensation) (Lot 1 and Lot 2)
- upgrade existing or new roads (unsurfaced) suitable for providing access to the OHTL towers worksites (Lot 1 and Lot 2)

Other key elements of the Project addressed by the ESMP include:

- construction camp and laydown including accommodation facility
- water supply
- equipment and material supply chain
- Worker employment and welfare

Table 2 summarises the key technical features of each OHL.

Table 2: Summary of OHTL characteristics

	Lot 1	Lot 2
<b>Circuit type</b>	Single or double	Single or double
<b>Number of phases</b>	2 or 3	2 or 3
<b>Approximate length of OHTL</b>	127 km	10 km (2 x 5 km LILO)
<b>Tower Type</b>	Combination of suspension, angle and terminal towers	Combination of suspension, angle and terminal towers
<b>Number of suspension towers</b>	~340	~21
<b>Number of angle towers</b>	~20	~6
<b>Tower height</b>	30 to 40 m.	30 to 40 m.
<b>Typical Span</b>	300 m to 400 m.	300 m to 400 m.
<b>Optical Ground Wire (OPGW)</b>	Yes	Yes

## 2.2 Project Location

Figure 1 provides an overview of the location of the two lots in the wider region. The Sarimay-Dzhankeldy OHTL (Lot 1) routes through three provinces: Bukhara province (Peshku districts), Khorezm province (Tuprokkala district), the Republic of Karakalpakstan and the villages of Kalaata and Dzhankeldy (see Figure 2).

The S-D OHTL starts from the existing Sarimay Substation (Khorezm province), which is located close to Nukus village (300 m) and Sarimay village (4.3 km), to a planned Dzhankeldy substation (Peshku administrative district of Bukhara province). The N-B-M LILO Lot 2 is entirely located in Bukhara province (Gizhduvan district) (see Figure 3).

Figure 1: Overview of the location of the Project Lots in the wider region

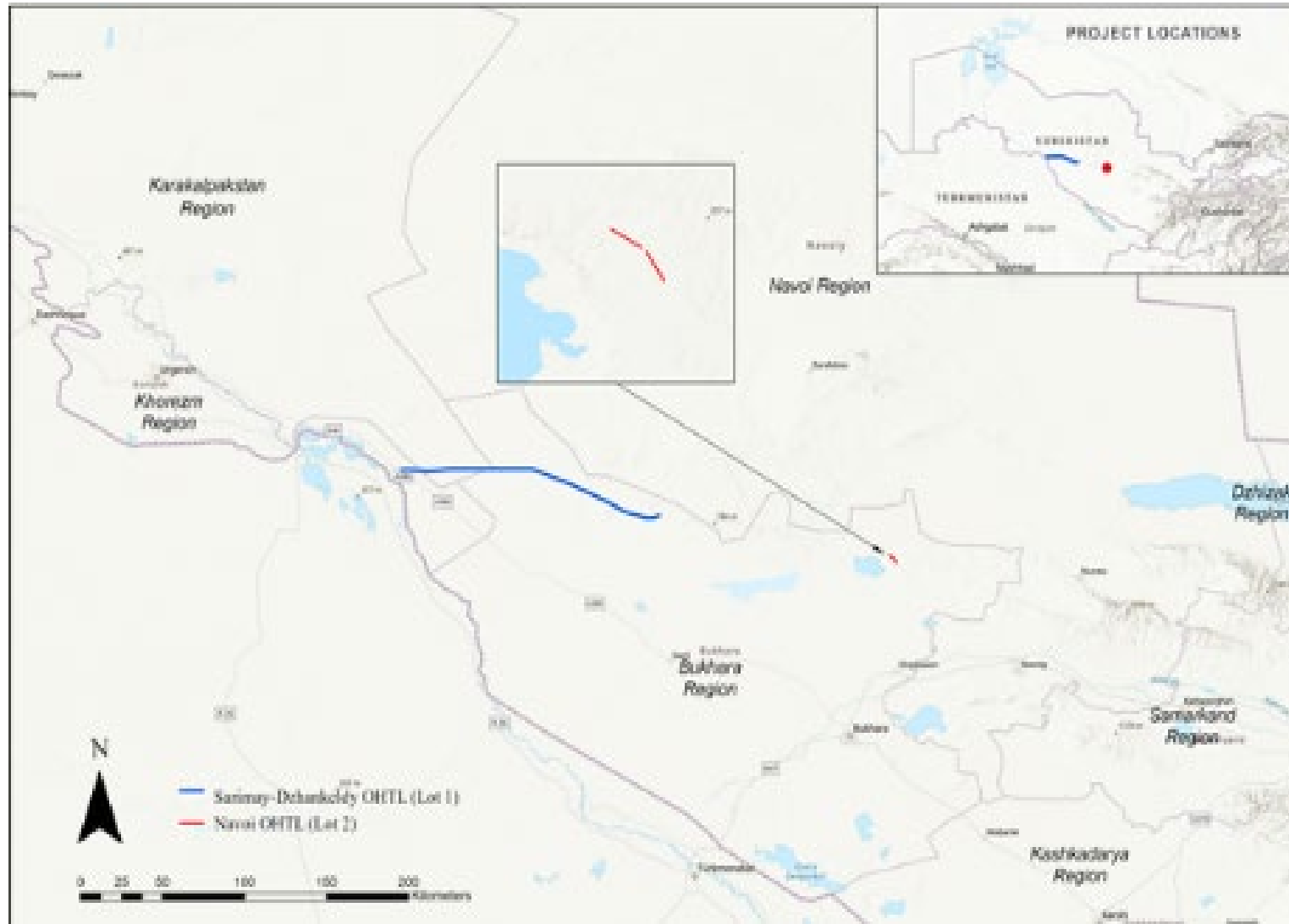

Figure 2: Project Location 500kV Sarimay- Dzhankeldy OHTL (Lot 1)

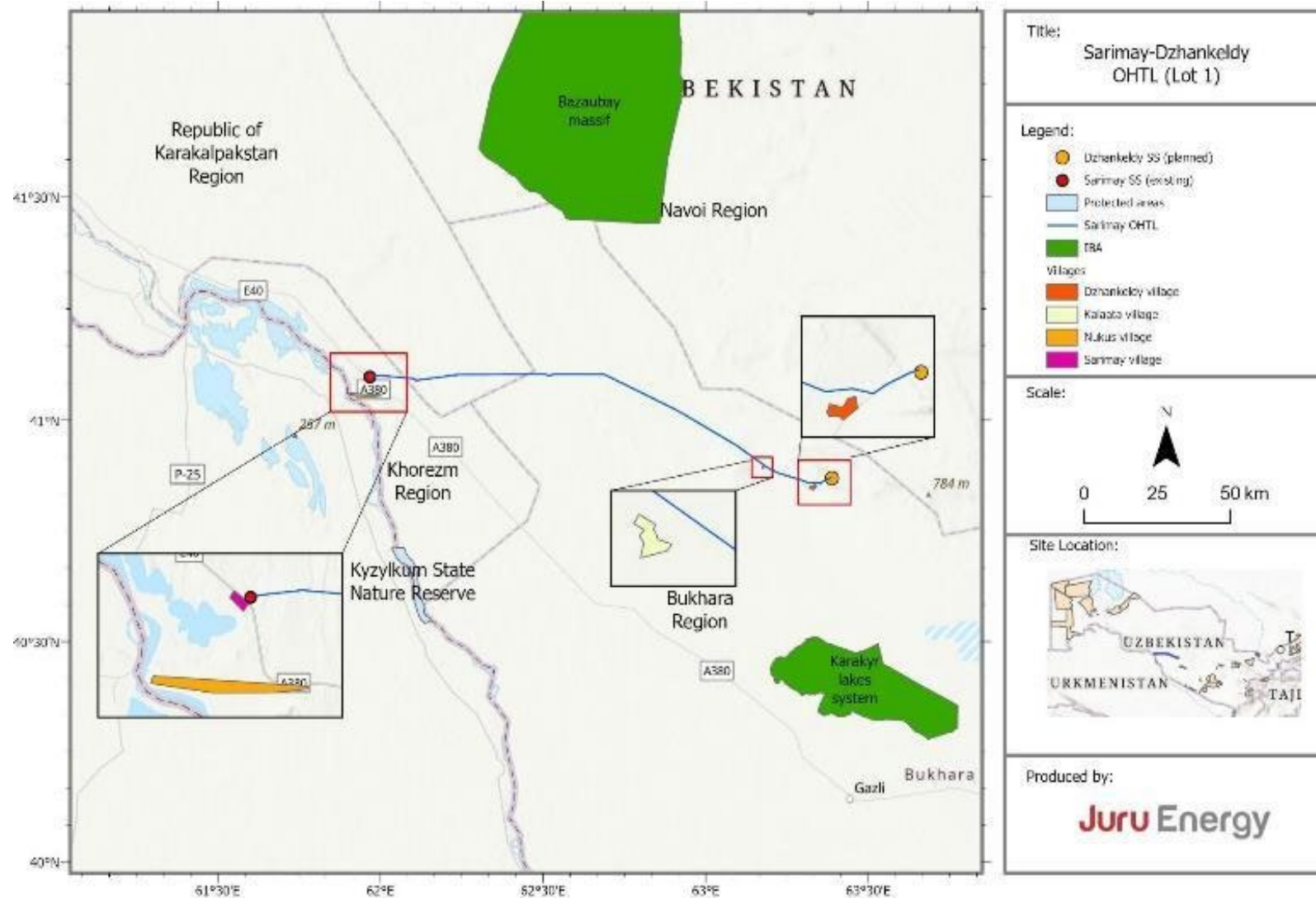
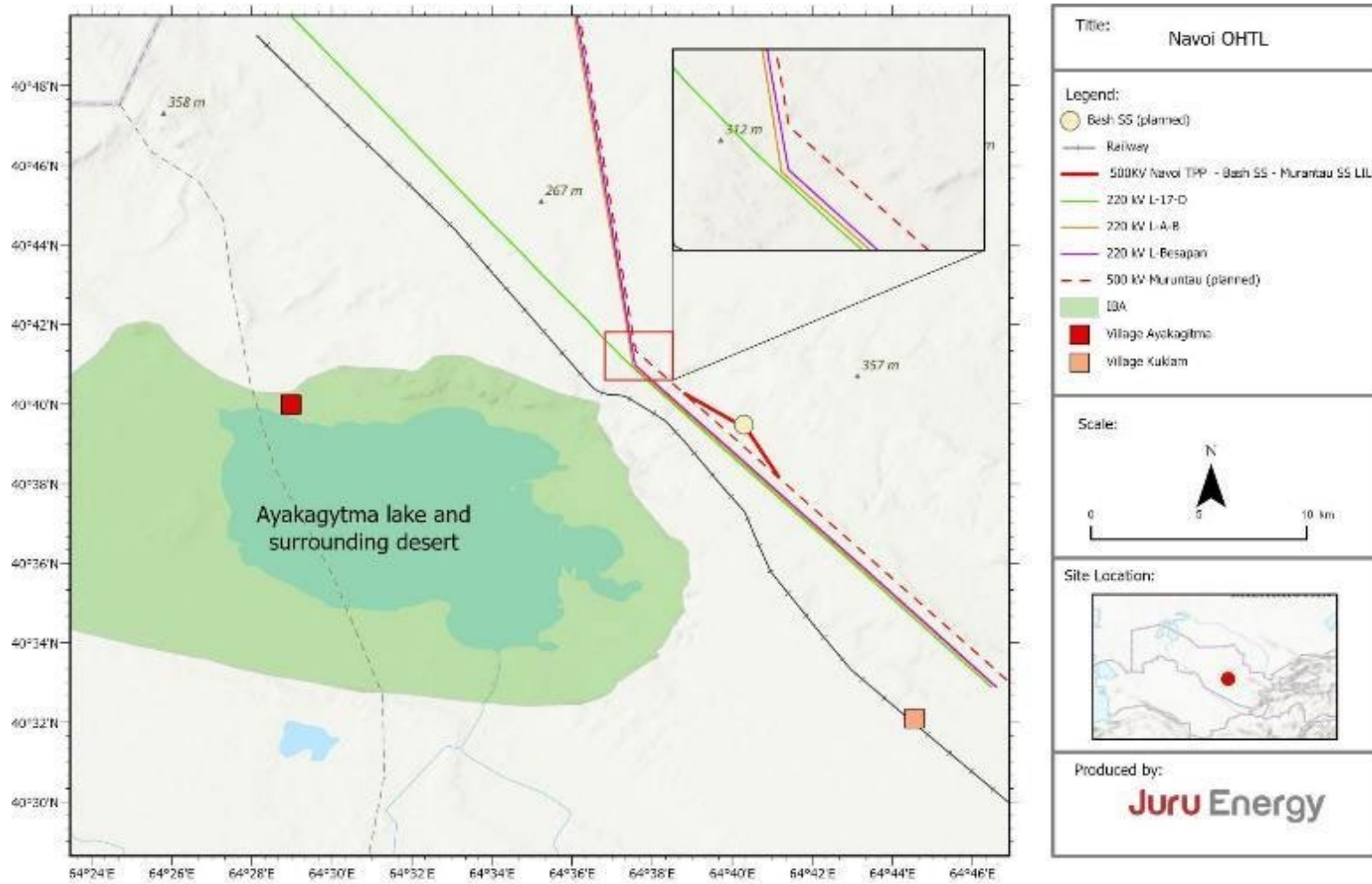

Figure 3: Project Location 500KV Navoi TPP - Bash SS - Muruntau SS LILO OHTL Connection (Lot 2)



The Navoi LILO OHTL is planned to be built near three existing 220 kV OHTLs. A railway road is approximately 3 km from the planned works. There are 10 kV distribution lines located near the railway. These start at "Tinchlik" railway stations and end at "Uchkuduk" railway station. Uzbekistan Railway JSC manages the railway lines.

A simplified line diagram illustrating the proposed Project Lots and their connection to the region's immediate transmission network is provided in Figure 4<sup>1</sup>.

Figure 4 Simplified schematic of the proposed Project at wider 500kV transmission network

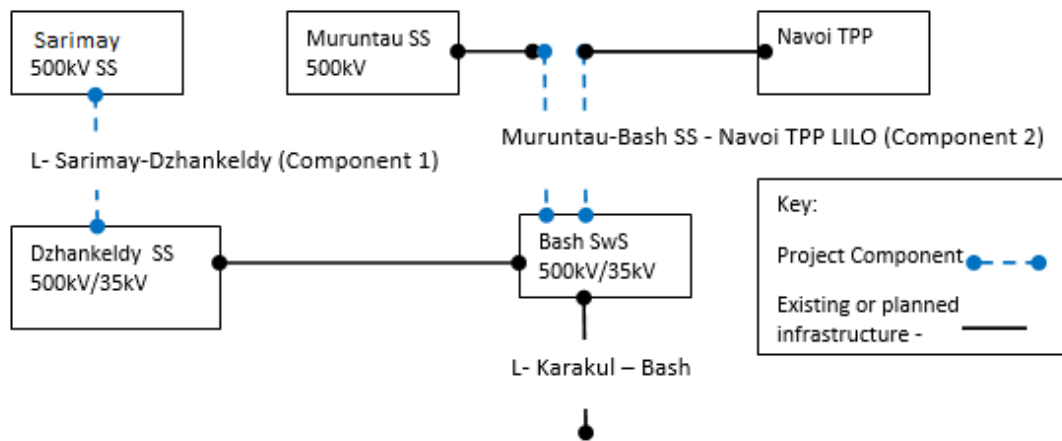

### 2.3 Project receptors

Key receptors along Lot 1 and Lot 2 and in the wider impact area are highlighted in Figure 5 and Figure 6.

1 Other lines in the vicinity of the Bash SS are i) 220 kV line between Navoi TPP - Besopan SP (Switching Point), ii) - 220 kV line between Substation "A" - Besopan SP, dispatching name of the line - "L-A-B ", iii) - 220 kV line between Navoi TPP - Substation "D", dispatching name of the line - "L-17-D" (refer to Figure 4).



Figure 5: Receptors within the direct AOI Lot 1

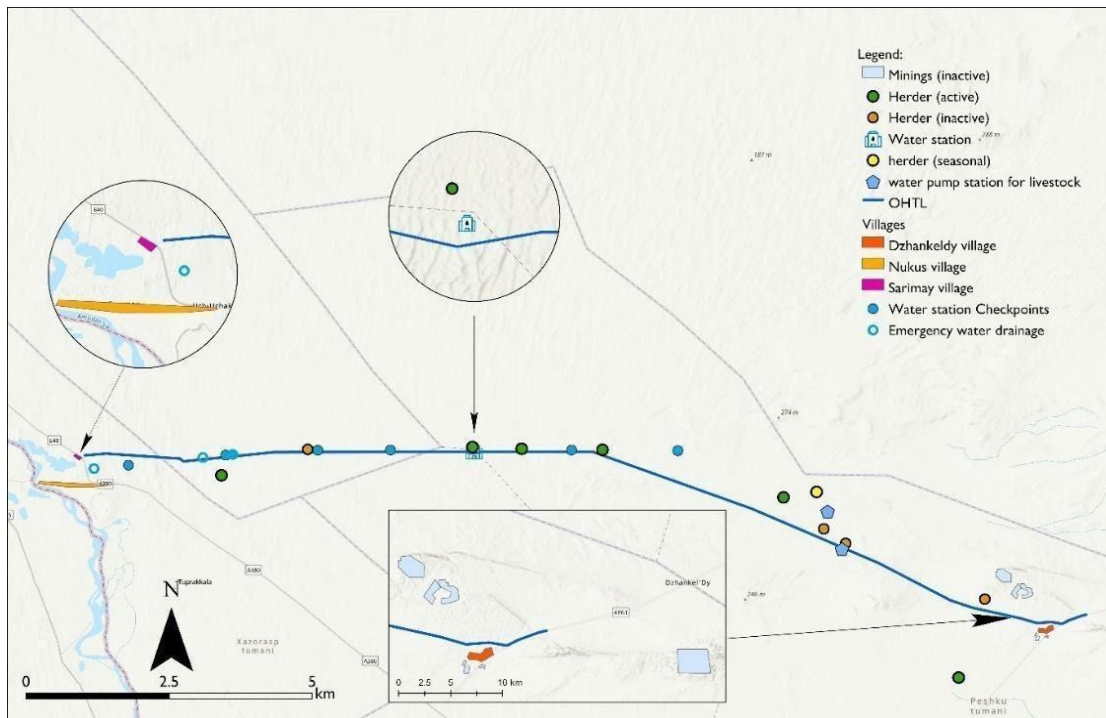
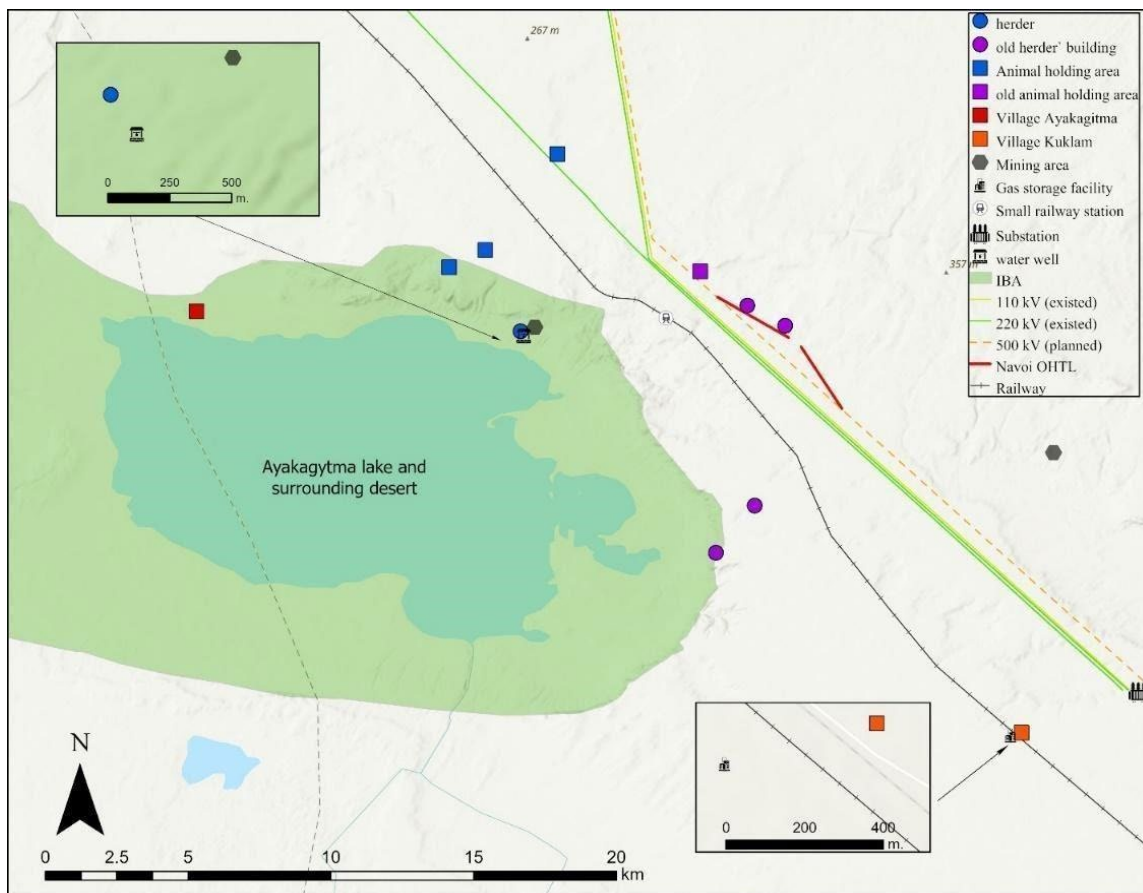

Figure 6: Receptors within the direct AOI Lot 2



## 2.4 Land requirements

For newly designed 500 kV OHTL, buildings and structures must be set back 30 m from the outermost conductor on either side of the OHTL and this forms the ROW or servitude. The state owns all land in Uzbekistan. The owners of the land rights along the Project ROW are the government-owned Committee for Development of Sericulture and Wool Industry, and the company managing the land is the Dzhankeldy LLC. The Project will need to obtain servitude rights over the land for the OHTL and any permanent and temporary access roads (unsurfaced). J.S.C NEGU will enter into a servitude agreement with the landowner (Committee for Development of Sericulture and Wool Industry).

Procedures for obtaining the use of a ROW in Uzbekistan are well defined. Calculation and compensation of losses to those with land rights will be performed following national regulations ensuring landowners, land users, and lessees are liable to be fully refunded (including the lost profit) in the case of limitation of their rights from the construction or operation of the Project. Land law relating to servitude in Uzbekistan also protects the owner/user and does not deprive the owner of their parcel's possession, use, and disposition rights.

The ESIA has assessed potential livelihood losses, summarised later in this NTS. Permanent land take will be for the OHTL tower footprints only. Grazing and other activities may continue under the line once operational. Work at the substations will be entirely within the existing substation footprints.

Additional requirements over and above national laws for compliance with EBRD PR5 are set out in the Project Livelihood Restoration Plan (Volume VI).

## 2.5 Project components

An OHTL is the structure by which electrical energy is transmitted from one location to another. The main components of an OHTL are the **electrical conductors (wires)**, which transmit the electricity and are suspended from **steel towers** by **insulators**. The towers are fixed to the ground with **cement foundations** or, in some cases, guy wires. The typical footprint is 10 m by 10 m (100m<sup>2</sup>).<sup>2</sup> Insulators isolate the towers from the live wires that carry the electricity.

## 2.6 Development and construction activities

There are four main stages of the Project cycle, pre-construction, construction, operation and decommissioning. Pre-construction work includes finalising the design, recruitment and procurement of equipment and site setup.

<sup>2</sup> Footprint is defined as the outer of the foundation columns at ground level

Figure 7: Stages in the project cycle

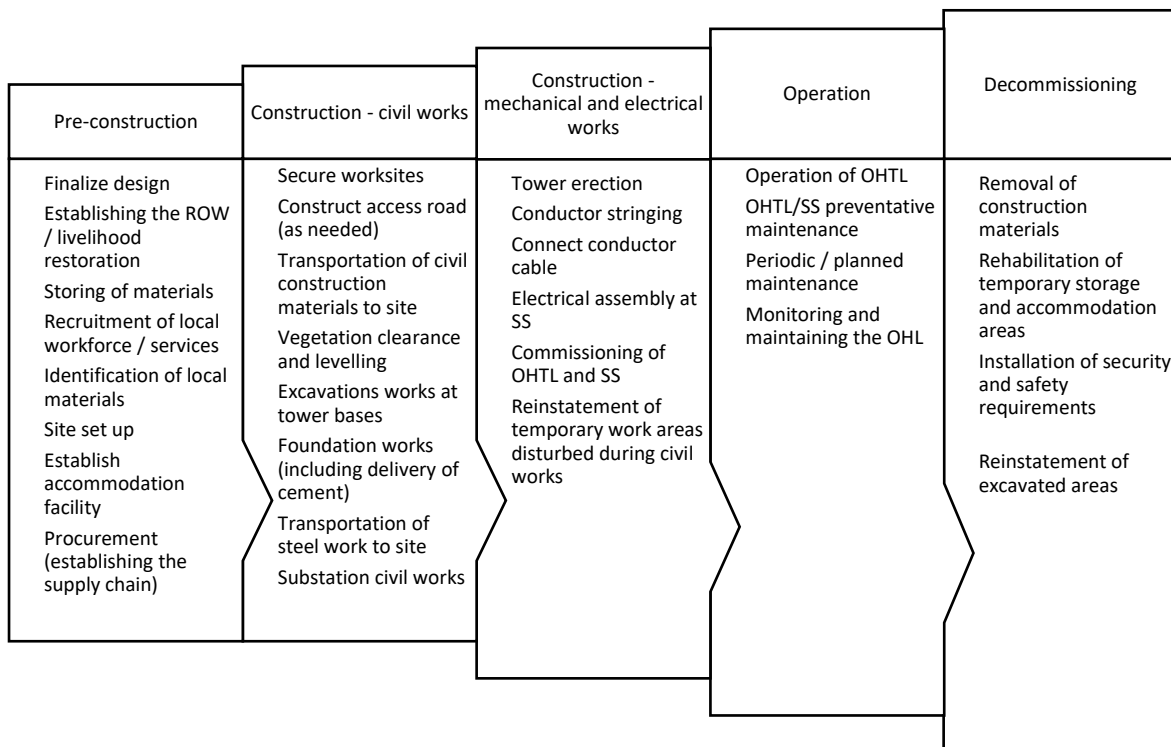

Construction typically progresses sequentially by one or more teams working along the whole or sections of the OHTL route. The key phases of the development are site clearance (rocks, utilities, vegetation), enabling works to establish vehicle access to each tower location, civil works (tower foundation works), steel delivery, steel erection, conductor stringing and then commissioning. A laydown area will be established for each Lot at a location central to the line and close to the main delivery rail station. Smaller and temporary equipment storage sites will also be established at strategic locations along the route to store key plant equipment and materials; these may also move along the OHTL following the construction works.

It may also be necessary to establish borrow pits along the route to provide aggregate to support the construction works, including road building. Workers' accommodation is likely to be a temporary work camp or more permanent construction phase accommodation in nearby settlements. At this time, the water source for the construction process is unknown. Materials and equipment will likely be delivered to the nearest railway station (Sarimay/Navoi) and then delivered to a central Materials and Equipment laydown area (location to be determined) before offloading equipment and materials for transfer to the worksites.

JSC NEGU will operate the OHTL and implement preventative, and emergency maintenance works following their corporate operations and maintenance (O&M) procedures. The substations with either be remotely operated or have one or two permanent workers (operating in a shift system). The substation maintenance works will be intermittent and within the operational site boundary. The expected lifetime of the infrastructure is 30 to 40 years (at least). At the end of its lifetime, options will be considered to replace the OHTL, repair it or remove all infrastructure from the site.

Decommissioning will fall into one of two categories:

- End of life decommissioning (~40 years); and
- Temporary worksites decommissioning (e.g. borrow pits, accommodation sites).

## 2.7 Project schedule

The development schedule is anticipated as set out in Table 3.

Table 3: Current anticipated development schedule

<b>Activity</b>	<b>Date</b>
Project Categorisation	August 2021 (completed)
Scoping and route definition	October 2021 (completed)
Consultation on draft ESIA	January 2022
Finalisation of the Submission of draft ESIA	January 2022
EBRD 120-day disclosure period	February 2022 to May 2022
Finalise ESIA (including public consultation comments and ongoing studies)	July 2022
EBRD Board of Director's consideration and Project signing	June 2022
Financial close	Immediately after signing
Pre-mobilisation (finalisation of route corridor, tower micro-siting, planning and design)	2023
Construction Start	2023
Construction End	2024
Expected Lifetime	Approx. 30 years or more

### 3 Regulatory Framework

#### 3.1 Key requirements

The Project must comply in all respects with all relevant Uzbekistan Laws and statutes for management of the environment (Environmental Law), land rights, labour and health and safety, including requirements of international and regional environmental agreements, conventions and treaties as ratified by Uzbekistan (such as ILO conventions) and the EBRD Environmental and Social Policy 2019 including EBRD Performance Requirements (one to eight and ten), relevant EU substantive standards and GIP.

The following section provides further information on the key Laws, regulations and Lender requirements applicable to the Project.

#### 3.2 Permits and approvals

For the construction (and decommissioning) phase, the Contractor is responsible for obtaining and maintaining all necessary consents for the construction and operation of the Project with the support of NEGU. All necessary consents must be obtained and provided to NEGU before any works commence. The developer is responsible for complying with the specific requirements of relevant environmental and other construction and operation permits for the entire duration of their scope of work. During operation, any consents and authorisation will be the responsibility of NEGU.

Based on local legal requirements, required permits and licenses related to the project are listed in Table 4 below.

Table 4: Required permits and licenses

Permit / Required Activity	Permit Title	Issuing Authority	Implementing Law	Responsible Party for Obtaining License
Pre-construction				
Construction activities	Construction Permit	Khokimiyats of Project region	<ul style="list-style-type: none"> <li>- Law “On licensing, permitting and notification procedures”, No. ZRU-701 of 14.07.2021;</li> <li>- Decree of the Cabinet of Ministers “On measures to further improve the procedures for providing free land plots for entrepreneurial and urban planning activities”, No. 1023 dated 12.20.2019.</li> </ul>	NEGU
Construction activities	The Positive Conclusion of SEE for the national EIA report (Stage I and Stage II)	SCEEP	<ul style="list-style-type: none"> <li>- Law «On Nature Protection» (1992);</li> <li>- Law of the Republic of Uzbekistan “On Ecological Expertise” (2000); and</li> <li>- Regulations "On the State Environmental Expertise" (SEE), approved by the Resolution of Cabinet</li> </ul>	NEGU

Permit / Required Activity	Permit Title	Issuing Authority	Implementing Law	Responsible Party for Obtaining License
			of Ministers No. 541 "On further improvement of the environmental impact assessment mechanism" (2020).	
Construction activities	Cultural Heritage Clearance	Ministry of Culture of Uzbekistan	- Law on the Protection and Use of Cultural Heritage Objects (2001)	NEGU
Pre-commissioning				
Construction activities	The Positive Conclusion of SEE for the national EIA report (Stage III)	SCEEP	- Law «On Nature Protection» (1992); - Law of the Republic of Uzbekistan "On Ecological Expertise" (2000); and - Regulations "On the State Environmental Expertise" (SEE), approved by the Resolution of Cabinet of Ministers No. 541 "On further improvement of the environmental impact assessment mechanism" (2020).	EPC Contractor

### 3.3 National regulatory framework

#### 3.3.1 Law on Environmental Control, 2013 as Amended in 2021

The main objectives of this law include:

- Prevention, detection and suppression of violation of legislative requirements relating to environmental protection and rational use of natural resources.
- Monitoring the state of the environment, identifying situations that can lead to environmental pollution, irrational use of natural resources poses a threat to the life and health of citizens.
- Determination of compliance with environmental requirements of any ongoing economic development activities.
- Ensuring compliance with the rights and legitimate interests of legal entities and individuals performing their duties concerning environmental protection and sustainable use of natural resources.

Article 7 of this law states that the objects of environmental control are:

- Land, its subsoil, waters, flora and fauna, and atmospheric air.
- Natural and manufactured sources of impact on the environment.
- Activities, actions or inaction that may lead to pollution of the environment and irrational use of natural resources create a threat to the life and health of citizens.

### 3.3.2 Environment

The following Laws are relevant to the Project:

- The Law of the Republic of Uzbekistan “On Water and Water Use” (1993) as amended in 2020.
- The Law of the Republic of Uzbekistan “On Ecological Expertise” (2000) as amended in 2021.
- The Law of the Republic of Uzbekistan “On Atmospheric Air Protection” (1996, amended on 28.09.2020).
- The Law of the Republic of Uzbekistan “On Protection and Use of Vegetation” (1997) as amended in 2016.
- The Law of the Republic of Uzbekistan "On Protection and Use of the Wildlife" (1997) as amended in 2016.
- The Law of the Republic of Uzbekistan “On Protected Natural Reserves” (2004) as amended in 2020.
- The Law of the Republic of Uzbekistan “On Wastes” (2002) as amended in 2019.
- The Law “On the sanitary and epidemiological wellbeing of the population” (2015) as amended on 03.09.2021.
- The Resolution of the Cabinet of Ministries of the Republic of Uzbekistan №541 “On further improvement of the environmental impact assessment mechanism” (2020).
- The Resolution of Cabinet of Ministries of the Republic of Uzbekistan №820 “On measures to further improve the economic mechanisms for ensuring nature” dated on 11th October 2018.
- The Resolution of the Cabinet of Ministers of the Republic of Uzbekistan No 14. “On approval of the regulation on the procedure for the development and agreement of projects with environmental standards”.
- Resolution of Cabinet of Ministers of the Republic of Uzbekistan No.95 “On approval of general technical regulations of environmental safety” (2020).

### 3.4 Land Law

The following land laws are relevant to the Project:

- Civil Code of the Republic of Uzbekistan (1995) as amended on 12.10.2021.
- Land Code of the Republic of Uzbekistan (1998) as amended on 17.08.2021.
- Law of the Republic of Uzbekistan on State Land Cadastre No.666-I of 28.08.1998.
- Presidential Decree № UP-5742 "On measures for the efficient use of land and water resources in agriculture”.
- Presidential Decree № UP-5495. Decree “On measures on cardinal improvement of the investment climate in the Republic of Uzbekistan”.
- Resolution № 146 of the Cabinet of Ministers (2011) “On the procedure for compensation for losses of landowners, users, tenants and owners, as well as losses of agricultural and forestry production”.
- Resolution № 911 of the Cabinet of Ministers (2019) “On the procedure for withdrawal of land plots and compensation to owners of immovable property located on the land

plot”.

### 3.5 Labour and Employment

The labour policy in Uzbekistan is applied at the national government level and is reflected in the relevant laws, regulations, and national social programmes.

- Labour Code of the Republic of Uzbekistan 1995 as amended on 03.08.2021.
- Law “On the employment of the population” No. 642 of 20.10.2020.
- Joint Decree of the Ministry of Labor and Social Protection of the Population (No. 33 K / B) and the Ministry of Health of the Republic of Uzbekistan (No. 13) "On approval of the list of jobs with unfavorable working conditions, where the employment of persons under 18 years is prohibited", registered by the Ministry of Justice of the Republic Uzbekistan, dated July 29, 2009, No. 1990;
- Decree No. 133 of 11 March 1997 to approve normative acts necessary for the realisation of the Labour Code of the Republic of Uzbekistan.
- Decree of the Cabinet of the Ministers No. 1011 of 22 December 2017 "On perfection of the methodology of definition of the number of people in need of job placement, including the methodology for observing households with regard to employment issues, also for the development of balance of labour resources, employment and job placement of population”.
- Decree of the Cabinet of the Ministers No. 965 of 5 December 2017 "On the measures of further perfection of the procedure of establishment and reservation of minimum number of job places for the job placement of persons who are in need of social protection and face difficulties in searching employment and incapable of competing in the labour market with equal conditions”.
- Decree No. 964 of 5 December 2017 "On the measures for perfection of the activity of self-government bodies aimed at ensuring employment, firstly for the youth and women”

Relevant health and safety norms and standards include:

- Safety Rules for the Operation of Electrical Installations, approved by order of "UZGOSENERGONADZOR", 2006.
- Rules for Electrical Installations, approved by order of "UZGOSENERGONADZOR", 2004.
- KMK 3.01.02-00 Occupational Health and Safety in Construction Works.
- General Requirements of Fire Safety in the industrial sectors, approved by order of "UZGOSENERGONADZOR", 2004.
- Fire Safety Rules for Energy Utilities, approved by order of "UZGOSENERGONADZOR", 2004.

As a member of the International Labour Organization (ILO) since 1992, Uzbekistan has ratified 17 ILO conventions, including the eight fundamental conventions (bold) as set out in Table 5.



Table 5: Labour Conventions ratified by Uzbekistan

Convention	Date
CCPR - International Covenant on Civil and Political Rights (1966)	28-Sep-95
CEDAW - Convention on the Elimination of All Forms of Discrimination against Women	19-Jul-95
Convention on the Elimination of All Forms of Intolerance and of Discrimination Based on Religion or Belief (1981)	30-Aug-97
<b>C029 - Forced Labour Convention, 1930 (No. 29)</b>	<b>13-Jul-92</b>
C047 - Forty-Hour Week Convention, 1935 (No. 47)	13-Jul-92
C052 - Holidays with Pay Convention, 1936 (No. 52)	13-Jul-92
C081 - Labour Inspection Convention, 1947 (No. 81)	19-Nov-19
<b>C087 - Freedom of Association and Protection of the Right to Organise Convention, 1948 (No. 87)</b>	<b>12-Dec-16</b>
<b>C098 - Right to Organise and Collective Bargaining Convention, 1949 (No. 98)</b>	<b>13-Jul-92</b>
<b>C100 - Equal Remuneration Convention, 1951 (No. 100)</b>	<b>13-Jul-92</b>
C103 - Maternity Protection Convention (Revised), 1952 (No. 103)	13-Jul-92
<b>C105 - Abolition of Forced Labour Convention, 1957 (No. 105)</b>	<b>15-Dec-97</b>
<b>C111 - Discrimination (Employment and Occupation) Convention, 1958 (No. 111)</b>	<b>13-Jul-92</b>
C122 - Employment Policy Convention, 1964 (No. 122)	13-Jul-92
C129 - Labour Inspection (Agriculture) Convention, 1969 (No. 129)	19-Nov-19
C135 - Workers' Representatives Convention, 1971 (No. 135)	15-Dec-97
<b>C138 - Minimum Age Convention, 1973 (No. 138) Minimum age specified: 15 years</b>	<b>06-Mar-09</b>
C144 - Tripartite Consultation (International Labour Standards) Convention, 1976 (No. 144)	13-Aug-19
C154 - Collective Bargaining Convention, 1981 (No. 154)	<b>15-Dec-97</b>
<b>C182 - Worst Forms of Child Labour Convention, 1999 (No. 182)</b>	<b>24-Jun-08</b>
C187 - Promotional Framework for Occupational Safety and Health Convention, 2006 (No. 187)	14-Sep-21
EU Partnership and Cooperation Agreement (1996)	21-Jun -96
P029 - Protocol of 2014 to the Forced Labour Convention, 1930	16-Sep-19
Universal Declaration of Human Right (1948)	1991

Measures have been enacted via a national action plan to implement these conventions into national law, including a legal and institutional framework to prevent forced labour. The legislation of the Republic of Uzbekistan (Constitution, Labour Code, Law on Employment)

prohibited the use of child and forced labour. Article 7 of the Labour Code stipulates that forced labour, namely compulsion to perform work under the threat of some form of punishment (including as a means of labour discipline), is prohibited.

### 3.6 Cultural heritage

Legislation in Uzbekistan relating to archaeology and cultural heritage includes:

- The Law of the Republic of Uzbekistan № 269-II dated August 2001 “On the protection and use of the sites and objects of cultural heritage”.
- Law on Protection and Use of The Objects of Archaeological Heritage (2009), No. ZRU-229.
- Resolution of the President of the Republic of Uzbekistan № RP-4068 dated December 19, 2018 “On measures for improving actions for the protection of material cultural heritage objects”.
- Resolution of the Cabinet of Ministers of the Republic of Uzbekistan № 846 dated October 4, 2019 “On approval of the national list of real state sites and objects of material cultural heritage”.

These laws offer a framework for protecting cultural heritage objects (CHO), which are the national property of the people of Uzbekistan, including sites, monuments, objects of tangible and intangible cultural heritage (ICH) and objects of archaeological heritage, through a system of state registration.

The relevant regional cultural heritage departments under the Ministry of Tourism and Sports issue field investigation permits and approve the scientific report for each permit issued. Local khokims and other district bodies may also hold local records of importance.

The Criminal Code of the Republic of Uzbekistan includes provisions that prohibit the intentional destruction or damage of objects of tangible cultural heritage under state protection, with further protections in place to protect cultural property in PAs, in particular protected historical and cultural territories, without first obtaining permission.

### 3.7 National norms and standards for transmission projects

A key standard relevant to the establishment of OHTLs in Uzbekistan is SanPiN No.0350-17 “For the protection of atmospheric air in populated areas of the Republic of Uzbekistan” (2017). This standard address health protection zones (HPZ), which may also be known as setbacks, for OHTL’s. According to SanPiN No.0350-17, section 2.23.4, an HPZ must be established to protect the population from the effects of an OHTL's electric field. HPZ’s are defined as the land along the route of a high-voltage OHTL in which the electric field strength exceeds 1 kV/m. For newly designed OHTL, buildings and structures must be set back the following distances on either side of the OHTL<sup>3</sup>:

- 20 m for OHTL with a voltage of 330 kV.
- 30 m for OHTL with a voltage of 500 kV.
- 40 m for OHTL with a voltage of 750 kV.

---

<sup>3</sup> The HPZ (set back) is defined as the distance from the outermost wires in a direction perpendicular to the OHTL.

- 55 m for OHTL with a voltage of 1150 kV.

Other relevant national laws and regulations to OHTL projects include:

- Resolution of Cabinet of Ministers of the Republic of Uzbekistan No.95 “On approval of general technical regulations of environmental safety” (2020).
- Decree of the Cabinet of Ministers of the Republic of Uzbekistan No.1050 “On approval of rules for protection of power grid facilities, 2018”.
- SanPiN & Norms No. 0236-07 “Sanitary norms and rules to ensure safety for people living near high voltage power transmission lines, 2007”.

### 3.8 EBRD Requirements

The Project must implement the E&S requirements of the EBRD as set out in the following:

- The European Bank for Reconstruction and Development (EBRD) Environmental and Social Policy 2019 (ESP 2019).
- EBRD Performance Requirements (PRs)<sup>4</sup>:
  - PR1 – Assessment and Management of Environmental and Social Risks and Impacts.
  - PR2 – Labour and Working Conditions.
  - PR3 – Resource Efficiency and Pollution Prevention and Control.
  - PR4 – Health, Safety and Security.
  - PR5 – Land Acquisition, Restrictions on Land Use and Involuntary Resettlement.
  - PR6 – Biodiversity Conservation and Sustainable Management of Living Natural Resources.
  - PR7 – Indigenous Peoples.
  - PR8 – Cultural Heritage.
  - PR10 – Information Disclosure and Stakeholder Engagement.
- World Bank Group (WBG) Environment, Health and Safety (EHS) Guidelines including:
  - WBG General EHS Guidelines (April 2007) cover the four areas of the environment; occupational health & safety (OHS); community health & safety (CHS); construction and decommissioning; and
  - WBG EHS Guidelines Electric Power Transmission and Distribution (April 2007).

The Project must also refer to relevant Good Industry Practice (GIP) including, but not limited to:

- Voluntary Principles on Security and Human Rights (est. 2000); (<http://www.voluntaryprinciples.org/>).
- United Nations Guiding Principles for “Protect, Respect and Remedy” Human Rights Framework (2011); (<https://www.business-humanrights.org/en/un-secretary-generals-special-representative-on-business-human-rights/un-protect-respect-and-remedy-framework-and-guiding-principles>).

<sup>4</sup> EBRD ESP 2019 and Performance Requirements

- United Nations Code of Conduct for Law Enforcement Officials; and (<https://www.un.org/ruleoflaw/blog/document/code-of-conduct-for-law-enforcement-officials/>).
- United Nations Basic Principles on the Use of Force and Firearms by Law Enforcement Officials (1990).
- Use of Security Forces: Assessing and Managing Risks and Impacts (February 2017).
- Worker's Accommodation: Processes and Standards (Guidance Note by IFC and EBRD, 2009).
- Stakeholder Engagement: A Good Practice Handbook for Companies Doing Business in Emerging Markets, 2007.

The EBRD is committed to promoting the adoption of European Union (EU) environmental principles, practices and substantive standards by EBRD-financed projects, where these can be applied at the project level, regardless of their geographic location. When host country regulations differ from EU substantive environmental standards, projects will be expected to meet whichever is more stringent. Relevant EU Directives include:

- EIA Directive (2011/92/EU as amended 2014/52/EU) on the assessment of the effects of certain public and private projects on the environment.
- Council Directive 2009/147/EC on the conservation of wild birds.
- Council Directive 92/43/EEC on the conservation of natural habitats and wild flora and fauna (Habitats Directive).
- Directive on Environmental Quality Standards in the Water Policy 2008/105/EC.

Fundamental conventions and agreements (in addition to the ILO conventions mentioned in Table 5) signed and ratified by Uzbekistan relevant to the Project are listed in Table 6.

Table 6: Conventions relevant to the Project that Uzbekistan has ratified

Convention name
<b>ENVIRONMENT / CLIMATE CHANGE</b>
United Nations Framework Convention on Climate Change (UNFCCC) (New York, 1992) (Official Gazette of RM no. 61/97), including Paris Agreement (joined April 2017)
United Nations Convention on Biological Diversity (Official Gazette of RM no. 54/97)
United Nations Convention to Combat Desertification (UNCCD) (26/12/2006)
Convention on the Prohibition of Military or Any Other Hostile Use of Environmental Modification Techniques (05/26/1993)
Basel Convention on the Control of Transboundary Movements of Hazardous Wastes and their Disposal (12/22/1995)
The Convention on the Protection and Use of Transboundary Watercourses and International Lakes
Convention Concerning the Protection of the World's Cultural and Natural Heritage (ratified 1993)
Convention for the Safeguarding of the Intangible Cultural Heritage. Paris (ratified 2008)
Convention on International Trade in Endangered Species of Wild Fauna and Flora (07/01/1997)
Convention on the Conservation of the Migratory Species of Wild Animals (Bonn Convention) (05/01/1998)

Convention name
Convention on Wetlands of International Importance especially the Waterfowl Habitats of Aquatic Birds (Ramsar Convention) (1975) (ratified 2001)
Vienna Convention for the Protection of the Ozone Layer (1985).
Montreal Protocol to Protect the Ozone Layer (including 1990 and 1999 amendments)
<b>ESPOO</b>
Convention on Access to Information, Public Participation in Decision Making and Access to Justice in Environmental Matters (Aarhus Convention) (Official Gazette of RM no. 40/99)

A full description of these requirements is provided in Volume II (ESIA Main Report).

## 4 Organisational framework

### 4.1 Overview

This chapter summarises the key roles and responsibilities for environmental health and safety (EHS) management structures and Project responsibilities proposed for this Project. The Project construction will be awarded to a winning Contractor under an open tender process for the development and construction phase (“EPC Contractor”). At the commercial operation date (CoD), the Project and all operations and maintenance (O&M) obligations will transfer to the responsibility of JSC NEGU. Other key bodies involved in the development and oversight of the Project are EBRD (as the Lender) and the State Committee for Ecology and Environmental Protection (SCEEP). The ESIA (Volume II) and SEP (Volume V) provide a full overview of Project stakeholders.

### 4.2 EPC Contractor selection

The Contractor selection process should require demonstration of the following competencies:

- ISO 14001 certified EMS or equivalent.
- ISO 45001 or equivalent certified health and safety management system.
- publicly disclosed Health and Safety Policy Statement.
- publicly disclosed Environmental Policy Statement.
- Human Resource Policy.
- Statements relating to any H&S convictions, reportable incidents or environmental breaches.
- Information on supplier qualification related to labour (forced labour, child labor, occupational health and safety and biodiversity)
- Experience implementing requirements of EBRD ESP 2019 on projects.

### 4.3 Project implementation structure

JSC NEGU will establish a project implementation team (PIT) to oversee the project development and construction. The PIT will include representatives from various disciplines and have overall responsibility for oversight of the project supported by relevant parties working for the Lenders. Relevant departments within NEGU will support the PIT to implement the Project requirements and establish the elements needed to oversee the construction

phase and implement the requirements of the operations phase. E&S oversight activities (during construction) will include:

- Review and approve the C-ESMP prepared by the EPC Contractor and specialist procedures and identify any areas for improvement.
- Oversee and ensure the implementation of the C-ESMP (with support from the Lenders and ensure all contractors (and sub-contractors) are following this framework ESMP.
- Establish and implement the requirements of the O-ESMP following this framework ESMP.
- Oversee reporting of environmental performance to the Lenders and SCEPP (during construction).
- Report environmental performance to SCEEP and Lenders following this framework ESMP.
- Review Contractors C-ESMP (with support from the Lenders) to ensure compliance with this framework ESMP.
- Undertake periodic audits and inspections to ensure mitigation measures are being implemented.
- Act as a key point of contact (in coordination with the EPC Contractor) on environmental and land matters with other government authorities, external bodies, and the public.
- Oversee the implementation of the Biodiversity Action Plan for the SEFG.

Currently there is no dedicated E&S team within JSC NEGU and therefore these responsibilities will fall to a third-party advisor or the existing operations and maintenance teams.

During operation, the Project will be maintained and operated by JSC NEGU. E&S requirements during implementation are defined below<sup>5</sup>. The key E&S activities of JSC NEGU during the operation phase will include:

- Establish an operational ESMS (corporate).
- Develop the operational ESMP (O-ESMP).
- Perform E&S related training for JSC NEGU staff.
- Monitor the performance of the Project against statutory requirements and the agreed objectives and targets.
- Conduct inspections and audits against the ESMP.
- Oversee maintenance works (risk method statements).
- Liaise with stakeholders on E&S matters

#### **4.4 Engineering, Procurement and Construction (EPC) Contractor**

The EPC Contractor will appoint key roles to support the implementation of E&S measures for the Project at the site level. The expected responsibilities of key personnel are summarised in Table 6.

The EPC Contractor's management team will be responsible for ensuring sub-contractor performance, including:

---

<sup>5</sup> Any requirements to strengthen the existing ESMS provisions within NEGU overseeing and implementing the requirements of this Project as outlined in Chapter 5 are incorporated into the Project ESAP.

- Adequately informing sub-contractors of the requirements of the Project ESMP (this document) and the Contractor C-ESMP and making sure they can adhere to the requirements.
- Making sub-contractors fully aware of all the E&S and occupational health and safety (OHS) and labour rights requirements that must be adhered to through back to back provision contract documentation.
- Identifying the procedures for monitoring and reporting on sub-contractor performance and integrate this into overall site reporting requirements.

#### **4.5 Subcontractors**

Subcontractors are expected to review and agree on the requirements of the C-ESMP and support the EPC Contractor and NEGU to work following these requirements.

Table 7: EPC Contractor E&S responsibilities (per Lot)

Role		Responsibility	Minimum qualification
<b>Contractor Manager</b>	<b>Site</b>	<ul style="list-style-type: none"> <li>Overall responsibility for health safety environment and social (HSES) on site</li> <li>Ensure sufficient budget and resources for HSES implementation</li> </ul>	Defined in technical specification
<b>H&amp;S<sup>6</sup> Manager</b>		<ul style="list-style-type: none"> <li>Day to day point of contact for implementation of the H&amp;S requirements of the framework ESMP</li> <li>Establish the site ESMS</li> <li>Oversee permitting compliance</li> <li>Prepare a detailed OHS plan</li> <li>Review site the Risk Assessments</li> <li>Monitor construction activities performance to ensure that identified and appropriate control measures are effective and ensure compliance with the OHS plan</li> <li>Provide or ensure necessary training (contractor team and casual labourers) to implement ESMP requirements</li> <li>Chair weekly HSE meetings and prepare / input into weekly construction progress report (including labour and social matters)</li> <li>Ensure the application and effectiveness of site permit to work systems and lockout procedures</li> <li>Oversee the investigation of all incidents/dangerous occurrences and recommend appropriate corrective &amp; preventive measures, environment and social incidents and labour incidents</li> <li>Undertake H&amp;S and emergency drills and report on the outcomes (including corrective actions)</li> <li>Liaise with the client's environmental manager, HR manager and community liaison officer (CLO)</li> <li>Ensure all sub-contractors comply with the OHS plan</li> <li>Report H&amp;S performance to PIT and Lenders</li> <li>perform regular inspections and audits</li> <li>Act as the first point of contact on H&amp;S matters</li> </ul>	<ul style="list-style-type: none"> <li>5 to 10 years of experience in the environmental &amp; social fields,</li> <li>At least 3-years of site-based experience</li> <li>Language skills – English, Russian.</li> <li>IOSH's safety, health and environment for construction site managers or equivalent,</li> <li>First aid basic certificate</li> <li>Knowledge of Uzbekistan health and safety requirements</li> <li>Full MS office knowledge and reporting skills and knowledge of risk management, method statement</li> </ul>
<b>H&amp;S Officers (ratio of 1 H&amp;S person per 50)</b>		<ul style="list-style-type: none"> <li>Support the above tasks</li> </ul>	<ul style="list-style-type: none"> <li>2 to 5 years of experience in the environmental &amp; social fields</li> </ul>

<sup>6</sup> The H&S and E&S Manger may be combined into one role HSES Manager.



Role	Responsibility	Minimum qualification
<p><b>personnel (OHTL, substation) (Lot 1 and Lot 2)</b></p>		<ul style="list-style-type: none"> <li>• Site based experience</li> <li>• Relevant qualifications</li> <li>• Knowledge of Uzbekistan environmental laws and requirements</li> <li>• Familiar with the requirements of EBRD PRs</li> </ul>
<p><b>Environmental Manager (Supported by environmental officers)</b></p>	<ul style="list-style-type: none"> <li>• Implement the E&amp;S requirements of the framework ESMP</li> <li>• Prepare a detailed C-ESMP</li> <li>• Oversee site E&amp;S matters</li> <li>• Provide or ensure necessary training (contractor team and casual labourers) to implement ESMP requirements</li> <li>• Participate in weekly HSE meetings and prepare / input into a weekly construction progress report</li> <li>• Ensure all sub-contractors comply with C-ESMP</li> <li>• Report E&amp;S performance to PIT and Lenders</li> <li>• Perform regular inspections and audits</li> <li>• Act as the first point of contact on E&amp;S matters</li> <li>• Establish site community GM</li> <li>• Act as CLO and implement the requirements of the SEP</li> <li>• Support NEGU with any community matters</li> <li>• Manage the environmental monitoring programme, including but not limited to noise, vibration and dust and review of the routine reports</li> </ul>	<ul style="list-style-type: none"> <li>• Three-year qualification in Environmental of Social Science or Management</li> <li>• Minimum of seven (7) years' experience working on a construction site of similar scale and nature</li> <li>• Knowledge of Lender standards, including IFC Performance Standards and World Bank EHS Guidelines</li> <li>• Knowledge of Uzbekistan environmental regulatory requirements is advisable</li> </ul>
<p><b>Biodiversity monitor (may be a third party contractor)</b></p>	<ul style="list-style-type: none"> <li>• Oversee the implementation of the Biodiversity management plan including pre-site clearance survey work, demarcation of sensitive areas as outlined in this framework ESMP.</li> <li>• To inform, explain and where necessary enforce the environmental policies associated with the Project.</li> <li>• To enforce the ban on all hunting across the Project area, raise awareness of the importance of the ban across all employees.</li> <li>• To undertake patrols across the Project area land and oversee and provide guidance on activities which may affect the biodiversity features within the Project area.</li> </ul>	<ul style="list-style-type: none"> <li>• Ecological qualifications relevant to the species under consideration.</li> </ul>

Role	Responsibility	Minimum qualification
	<ul style="list-style-type: none"> <li>• To undertake and arrange for the clear demarcation and signage which may prohibit entry to ecologically sensitive areas.</li> <li>• To provide advice to contractors regarding the ecological sensitivities within the Project area, and if necessary supervise contractors to ensure that they adhere to environmental requirements to minimise disturbance to flora and fauna.</li> <li>• To maintain working relations with local community groups; land-owners, land-managers and business interests (particularly those related to recreation and tourism) by maintaining close liaison with local individuals and communities.</li> <li>• Provide advice to NEGU, Contractor and Project staff, as necessary, in relation to the conservation and management of wildlife areas.</li> <li>• To design and implement the vegetation clearance and ecological monitoring requirements for the Project, as detailed in the ESIA</li> </ul>	
<p><b>Project archaeologist (may be a third party contractor) *Lot 1 only</b></p>	<ul style="list-style-type: none"> <li>• pre-construction surveys as outlined in this framework ESMP*(Lot 1 only).</li> <li>• Oversee the implementation of archaeological watching brief and</li> </ul>	<ul style="list-style-type: none"> <li>• Specialist in archaeological matters</li> </ul>
<p><b>CLO</b></p>	<ul style="list-style-type: none"> <li>• Oversee all external communications with the community as stated in the SEP</li> <li>• Oversee community grievance management</li> </ul>	<ul style="list-style-type: none"> <li>• CLO will be a locally sourced person with local language skills (Uzbek and Kazakh) and based at the site office</li> </ul>
<p><b>HR Manager</b></p>	<ul style="list-style-type: none"> <li>• Employee onboarding</li> <li>• Establish a worker grievance mechanism and worker code of conduct on-site (including GBVH referral pathways)</li> <li>• Implement the local hiring strategy</li> <li>• Audit all third-party contractors labour provisions at the outset of the Project</li> <li>• Undertake regular labour audits of subcontractor workers</li> <li>• Undertake regular inspections of labour accommodation</li> <li>• Disclose information not the relevant stakeholders including not limited information on including emergency preparedness and action plan) to applicable stakeholders (directly impacted stakeholders, nearby residents, government bodies, and local agencies, interested parties) and translation of the material into applicable languages pre-construction, during construction and pre-commissioning Communicating on GBV and SEA/SH Prevention and</li> </ul>	<ul style="list-style-type: none"> <li>• 5 to 10 years of experience in HR,</li> <li>• At least 3-years of experience working on infrastructure projects</li> <li>• Knowledge of Uzbekistan labour and HR requirements</li> <li>• Knowledge ILO conventions and their requirements</li> <li>• Full MS office knowledge and reporting skills and knowledge of risk management, method statement</li> </ul>

Role	Responsibility	Minimum qualification
	<p>Response (quarterly basis through construction via bilateral meetings with women, young girls and boys)</p> <ul style="list-style-type: none"> <li>● Manage interactions with any worker organizations or unions, as relevant, on site. Negate on behalf of the Project of collective agreements, as necessary.</li> <li>● Handle minor, straightforward issues related to a complainant request for information</li> <li>● Obtain clarification from other members of management concerning dealing with specific grievances, such as a need to notify the Project Company</li> </ul>	
<b>Security</b>	<ul style="list-style-type: none"> <li>● Ensure the Security Procedure is properly implemented</li> <li>● Ensure the Fire Prevention and Protection Procedure systems are prepared, available and closely monitored its implementation</li> <li>● Arrange the training for emergency response providers</li> <li>● Vet all security personnel</li> </ul>	<ul style="list-style-type: none"> <li>● 5 to 10 years of experience in security,</li> <li>● At least 3-years of site-based experience</li> <li>● Knowledge of international as well as national security requirements (i.e. the Voluntary Principles on Security and Human Rights)</li> </ul>
<b>Workers</b>	<ul style="list-style-type: none"> <li>● Comply with the basic site HSE rules</li> <li>● Receive induction training and HR training</li> <li>● Sign the Workers Code of Conduct and GBV/SEA Code of Conduct</li> <li>● Wear the specified PPE designated for the work area</li> <li>● Attend all planned toolbox talks, safety briefings, drills and training sessions arranged on their behalf</li> <li>● Comply with all reasonable instructions issued by the project HSE team</li> <li>● Report all incidents and accidents immediately to the relevant foreman</li> </ul>	<ul style="list-style-type: none"> <li>● As per individual job requirements</li> </ul>

#### **4.6 Lender**

The Lender will play a key role in reviewing and approving the C-ESMP and the O-ESMP, the Human Resources (HR) Policy, and all supporting plans and having an independent monitoring role throughout the construction process.

#### **4.7 SCEEP**

The State Committee on Ecology and Environmental Protection (SCEEP) is the main regulating body of state administration on environmental protection issues. The primary responsibilities of the SCEEP include ensuring the implementation of a unified state policy on environmental safety, environmental protection, and the use and reproduction of natural resources; and enforcing state control over the compliance of ministries, state committees, departments, enterprises, institutions, and organisations, as well as individuals, concerning the use and protection of land, mineral resources, water, forests, flora and fauna, and atmospheric resources. Structurally, the SCEEP consists of the central unit (located in Tashkent), regional units (oblast) and local (district) units.

## 5 Environmental and Social Management

### 5.1 Environmental and social management system (ESMS)

NEGU and the EPC Contractor and subcontractors must separately establish and maintain an environmental and social management system (ESMS) that addresses the requirements set out in EBRD ESP 2019 including:

1. Establish and maintain an ESMS and health and safety management system (HSMS) developed in the manner of international frameworks quality, occupational health and safety and environmental management such as ISO 9001, ISO 14001, and ISO 45001 that is proportionate to their role on the Project and the impacts identified in the ESIA.
2. Establish an Human Resources (HR) Policy that aligns with EBRD Performance Requirement 2 and specifically address issues including but not limited to: code of conduct; recruitment; compensation and benefits; official working hours; leave; termination; collective bargaining; child labour; forced labour and overtime to be adopted/reflected in the practices of ALL parties working on the Project.

The NEGU ESMS will consider oversight obligations on the EPC contractor for the construction phase, the requirements of the O-ESMP for the operations phase and requirements for implementing the Biodiversity Action Plan, SEP and local development obligations for the construction and operation phase as defined in chapter 6.

The EPC Contractor ESMS must cover the scope of the construction phase work and interface as necessary with the NEGU ESMS for all the topics outlined in chapter 6. The EPC Contractor must be responsible for all third-party subcontractors working following the EPC Contractor ESMS and HR Policy.

An effective ESMS must follow the “Plan, Do, Check, Act” principles of international management systems incorporating the elements outlined in Figure 8 and described below. For the topics covered by the ESMS, HSMS and the HR Policy, specific obligations are defined in Chapter 5.

JSC NEGU and the EPC Contractor ESMS will include a project specific E&S Policy and supporting procedures outlining how it is intended to implement the required elements of the ESMS to ensure works are executed in a responsible manner. Management topics to be addressed include:

- Legal and other requirements – establish and maintain a system for monitoring legal and other requirements in a systematic way.
- Risk assessment and control– procedure for assessment of risk and opportunities and management processes for each phase to prevent or mitigate adverse E&S impacts and enhance opportunities.
- Objectives and targets - construction phase objectives and targets must be defined in Project plans and monitored using project-specific Key Performance Indicators (KPIs)
- Operations management – procedures must be defined to manage the operations to be performed at site, including management of change and sub-contractor management.

- Documentation handling – establish a complete and up-to-date file of all relevant sources of information, records and documentation to evidence compliance with E&S requirements.
- Communication and participation – Procedures must be defined to support communications at all stages of the Project/ lifecycle as per the SEP and to ensure that personnel at the appropriate level and function know and understand their HSESS obligations and information. Further elaboration is provided in section 8.
- Training awareness and competence – procedures must be developed to oversee competence and training and recorded in a training and competence matrix for all E&S roles and engineering roles with E&S responsibilities. Training may include induction training, on the job training, specialist training related to the competencies required for specific roles. General awareness training must also be provided on the ESMS and other E&S matters including:
  - A general understanding of the health and safety and environmental risks associated with the works
  - Local, national, and international actions which are required to combat these risks
  - Notification of any specific receptor sensitivities
  - Emergency preparedness and response provisions
  - Requirements for waste management, materials management, traffic management, dust control, control of noise
  - Natural hazard risks
  - Requirements for H&S, environment and labour incident notification, investigation and reporting procedure
  - Stakeholder engagement requirements
  - Security requirements for the site
  - Labour grievance mechanism and code of conduct, welfare arrangements and key contract provisions
  - Worker code of conduct and workers grievance mechanism
- Monitoring, evaluation of compliance and reporting – develop a program of monitoring and reporting to enable E&S performance to be evaluated against project standards. The monitoring and reporting system must include a feedback loop to promote continual improvement. Minimum monitoring and reporting requirements for the Project are defined in section 7 below. This must include an accident and incident reporting procedure.
- Supervision, inspections and auditing - the EPC Contractor and JSC NEGU must establish a program and supporting procedures to supervise and measure the effectiveness of the management system. This should be through a combination of inspections, audits (internal and third party).
- Management review and planning – NEGU and Contractor management must demonstrate periodic review of the ESMS to ensure its continuing suitability, adequacy, and effectiveness

The EPC Contractor ESMS will be reviewed and accepted for use by NEGU and EBRD prior to mobilisation at site.

Figure 8: Components of an ESMS



## 5.2 Environmental and Social Management Plans

The relevant party (NEGU, EPC Contractor, other) as defined in the Project EPC contract must develop:

1. A construction environmental and social management plan (C-ESMP) with supporting procedures, forms and method statements (at least 60 days prior to mobilisation for site clearance works).
2. An operational environmental and social management plan (O-ESMP) with supporting procedures, forms and method statements (60 days prior to commercial operation date (COD)).
3. A decommissioning environmental and social management plan (D-ESMP) with supporting procedures, forms and method statements (at least 60 days prior to site mobilisation).

The C-ESMP, O-ESMP and D-ESMP refer to the following topic specific sub-plans as summarised in Table 8. An outline for these sub-plans is provided in Annex B (environmental management plans) and Annex C social management plans.

Table 8: Summary of Project management plans and sub-plans,

<b>Management Plan</b>	<b>Construction</b>	<b>Operation</b>	<b>Decommissioning</b>
Construction ESMP	X		
Occupational health and safety plan	X	X	X
Emergency Response Plan / Pollution Incident Control Plan	X	X	X
Vegetation Clearance and Rehabilitation Plan (temporarily cleared areas)	X		X
Site Waste Management Plan	X	X	X
Cultural Heritage Management Plan	X		
Accommodation management plan	X		X
Biodiversity Management Plan	X		X
Biodiversity Action Plan (SEFG) (NEGU)		X	
Pollution prevention and control (air, noise, dust, water use, water run off)	X		X
Livelihood Restoration Plan (pre-construction)	X		
Archaeological management plan including chance finds procedure	X		
Stakeholder Engagement Plan (including Grievance Mechanism) (NEGU)	X	X	X
Medical services plan (including COVID-19 Prevention Plan)	X		X
Labour management plan (including local employment protocol)	X		X
Internal communication plan	X		
Security Management Plan	X	X	X
Operational ESMP		X	
Decommissioning ESMP			X

## 6 Mitigation and Management Requirements

### 6.1 Introduction

The ESMP sets out requirements for the design, pre-mobilisation, construction (including site preparation) and operation phases of the Project.



## 6.2 Mitigation and Management Requirements - Design phase

Table 9: Mitigation and management requirements – design phase

Objective	Activity	Action	Responsibility	Timescales	Evidence
Avoid significant impacts to sensitive receptors from the construction works.	Design / EPC Contractor Technical Specification	<ul style="list-style-type: none"> <li>Line routing to maintain at least 200m between sensitive receptors and the line route.</li> <li>Specify tension stringing technique to avoid impact on habitat between the towers and stringing points.</li> <li>Grade temporary access roads so that their slope is not too large to avoid the build-up of fast-running run-off water during extreme precipitation events.</li> </ul>	NEGU (Technical Specification)  Contractor (Detailed design)	Pre-FC <sup>7</sup>  Pre-NTP <sup>8</sup>	EPC Contract  Approved Design
Address climate resilience measures in the technical design	Design / EPC Contractor Technical Specification	<ul style="list-style-type: none"> <li>Design OHTL for climate projections up to 2085 – consider the need to reinforce the structures or higher design standards (stronger winds, higher temperatures).</li> <li>Design access roads to consider short-term, extreme weather events.</li> <li>Design any drainage to account for increased or short-term extreme precipitation patterns.</li> <li>Design for increasingly frequent and extreme dust storms.</li> <li>Specify more effective cooling for substations and transformers, including retrofitting measures, improved shading, and choice of cooler locations where possible around the substation.</li> </ul>	NEGU (Technical Specification)  Contractor (Detailed design)	Pre-FC  Pre-NTP	EPC Contract  Approved Design
Reduce the use of raw materials/ potentially finite and	Design / EPC Contractor Technical Specification	<ul style="list-style-type: none"> <li>Substitute raw materials or inputs with less hazardous or toxic materials wherever economically and technically feasible.</li> <li>Identify opportunities to prevent waste production in the first instance.</li> </ul>	Contractor (Detailed design)	Pre-FC  Pre-NTP	EPC Contract

<sup>7</sup> pre-FC – Pre financial close

<sup>8</sup> pre-NTP – Pre-Notice to proceed

Objective	Activity	Action	Responsibility	Timescales	Evidence
or scarce resources.		<ul style="list-style-type: none"> <li>No groundwater to be used in the construction process.</li> <li>All drinking and potable water to be tankered to site from sustainable source.</li> </ul>			Approve Design
Ensure biodiversity mitigation measures are incorporated into the design	Design / EPC Contractor Technical Specification	<ul style="list-style-type: none"> <li>Specify Bird Flight Diverters on overhead, or static lines of the OHTL following GIP, within high risk portions of the lines (all of Lot 2 (40.687271° 64.625539° to 40.620080° 64.705109°), westernmost 5 km of Lot 1 (41.097761° 61.969967° to 41.098389° 62.029836°), eastern 33% of Lot 1 (41.008969° 62.943141° to 40.870647° 63.386358°))</li> <li>Specify Raptor safe” pylon designs for the entire OHTL               <ul style="list-style-type: none"> <li>Electrified cables suspended below, rather than above support structures</li> <li>≥2m of insulators at each attachment point of a powerline to a support structure</li> <li>≥2m separation between electrified cables</li> <li>Jumper cables suspended below insulators/support structures</li> </ul> </li> <li>Micro siting of pylons and access road to avoid takyrs to the extent possible within the potential habitat of SEFG</li> <li>Micro siting of pylons and access road to avoid <i>Tulipa lehmanniana</i> (Lot 2) and <i>Acanthophyllum cyrtostegium</i> (Lot 1) to the extent possible</li> <li>No access track along the entire ROW. Use existing road where possible to access the tower Work fronts.</li> </ul>	NEGU (Technical Specification)  Contractor (Detailed design)	Pre-FC  Pre-NTP	EPC Contract  Approve Design
Hazardous materials	Design / EPC Contractor Technical Specification	<ul style="list-style-type: none"> <li>Prohibit the following materials in EPC Contract:               <ul style="list-style-type: none"> <li>Asbestos</li> <li>PCB containing materials</li> <li>lead-based paints</li> </ul> </li> </ul>	NEGU (Technical Specification)  Contractor (Detailed design)	Pre-FC  Pre-NTP	EPC Contract  Approve Design

Objective	Activity	Action	Responsibility	Timescales	Evidence
		<ul style="list-style-type: none"> <li>pesticide, herbicides defined under Stockholm convention.</li> </ul>			
Safeguard the wellbeing and improve the living standards of those whose livelihoods are involuntarily displaced	Prepare Livelihood Restoration Plan (LRP)	<ul style="list-style-type: none"> <li>Identify resettlement specialist to define the Livelihood Restoration Plan (LRP)                             <ul style="list-style-type: none"> <li>Identify land use or resettlement impacts as a result of the project, based on the final design</li> <li>Determine compensation and livelihood restoration requirements</li> </ul> </li> <li>Implement livelihood restoration compensation</li> </ul>	NEGU/Contractor (Detailed design)/resettlement specialist	Pre-FC  Pre-mobilisation	LRP  LRP close out report
Schedule works to avoid key impacts	EPC Contract / Schedule	<ul style="list-style-type: none"> <li>Schedule groundworks outside the wet season (growing season) late autumn-early spring.</li> </ul>			

### 6.3 Mitigation and Management Requirements - Pre-mobilisation phase

Table 10: Mitigation and management requirements – pre-financing / pre-mobilisation (any mobilization to site except pre-construction survey work)

Objective	Activity	Action	Responsibility	Timescales	Monitoring / KPI
Comply with national permit requirements	Environmental permits (permanent)	<ul style="list-style-type: none"> <li>Obtain national Environmental Approval (Stage 1 or 2)</li> <li>Develop permit matrix (name, phase, requirements and lead) and set out a conditions register</li> </ul>	Contractor approved by NEGU/Lenders	Pre-Financial Close (FC)	Permit matrix – monthly updates
Implement robust ESMS for the duration of the Project	Site implementation from NTP to COD	<ul style="list-style-type: none"> <li>Establish project E&amp;S Policy</li> <li>Develop E&amp;S plans and procedures for implementing the E&amp;S requirements of the Project (Develop C-ESMP and subplans as defined below).</li> <li>Develop training and awareness program including training matrix and needs analysis, site induction, visitor induction, setting to work briefings, tools box talks and HR onboarding.</li> </ul>	Contractor approved by NEGU/Lenders	Pre-mobilisation	E&S Policy ESMS C-ESMP Internal communication procedure

Objective	Activity	Action	Responsibility	Timescales	Monitoring / KPI
		<ul style="list-style-type: none"> <li>Develop internal communication procedure including construction progress meetings, HSES progress meetings</li> <li>Develop inspection and audit program for the duration of the works covering all components and aspects of the works including H&amp;S, environment, labour and social.</li> <li>Establish an incident reporting and investigation procedure</li> <li>Establish reporting requirements (Lender, statutory, other)</li> <li>Establish system on site for control of documentation. The HSES file must contain documentation with evidence of all statutory obligations and Lender obligations.</li> <li>Establish an E&amp;S monitoring program</li> </ul>			Inspection and audit program Incident reporting and investigation procedure E&S monitoring program
Demonstrate Contractor capacity to implement the E&S requirements for the Project	Pre-mobilisation	<ul style="list-style-type: none"> <li>Define NEGU E&amp;S organogram</li> <li>Define Contractor E&amp;S organogram</li> </ul>	Sponsor organogram (approved by Lenders)  Contractor organogram approved by NEGU/Lenders	Pre-mobilisation	Organogram and CV's for all personnel
Demonstrate Contractor capacity to implement the E&S requirements for the Project	Pre-mobilisation	<ul style="list-style-type: none"> <li>Develop O-ESMP</li> </ul>	NEGU (approved by the Lenders)	Pre-COD <sup>9</sup>	O-ESMP

<sup>9</sup> Pre-COD - Pre-commercial operation date

Objective	Activity	Action	Responsibility	Timescales	Monitoring / KPI
Ensure transparent and robust supply chain	Selecting suppliers	<p>Develop Supply Chain and Procurement Policy that includes the following obligations:</p> <ul style="list-style-type: none"> <li>Prohibit forced labour at the site and in the supply chain</li> <li>Prohibit the hiring of child labour at the site and in the supply chain.</li> <li>Preference for using local suppliers where possible</li> <li>Maintain an employee register</li> <li>Preference suppliers who remove packaging waste for ultimate disposal (following Uzbek regulations and transboundary waste disposal obligations)</li> <li>Perform a supply chain due diligence / obtain the third-party supply chain due diligence reports to verify potential suppliers (Tier 1 and 2) credentials regarding the occurrence of forced labour child labour or occupational health and safety failures.</li> </ul>	Contractor approved by NEGU/Lenders	Pre-mobilisation	Supply Chain and Local Employment and Procurement (see Appendix C)
Promote the use of local workers on the Project	Procurement of local labour and contractors	<ul style="list-style-type: none"> <li>Set out key competencies for all roles with plenty of notice to mobilise local recruitment</li> <li>Identify hiring needs</li> <li>Identify local counterparts for advertising project needs (skilled workers and unskilled workers) who may be sourced from the local labour pool.</li> <li>Develop a <b>local employment procedure</b> for the Project, including: <ul style="list-style-type: none"> <li>Identify a mechanism for promoting women working on the Project</li> <li>Prioritise local unskilled/semiskilled local employees.</li> <li>Define the working terms and conditions (salary etc.) for each role</li> </ul> </li> <li>Nominate a EPC Contractor HR manager to oversee employment matters on the Project</li> </ul>	Contractor approved by NEGU/Lenders	Pre-mobilisation	<p>Local employment procedure</p> <p>EPC Contractor HR manager identified</p>
Implement good international practice (GIP)	Notification of works	<ul style="list-style-type: none"> <li>Plan ahead and give regulators advanced warning of potential problems and start of works</li> <li>Always display on site the emergency number for regulators and local community leaders at key worksites</li> </ul>	Contractor and NEGU	Pre-mobilisation	Monthly update via the PIT

Objective	Activity	Action	Responsibility	Timescales	Monitoring / KPI
for site management and coordination		<ul style="list-style-type: none"> <li>Ensure site personnel know the correct procedure for reporting incidents</li> </ul>			
	Managing sub-contractors	<ul style="list-style-type: none"> <li>Sub-contractors to provide work completion certificates and EHS certificates as proof of their past environmental performance prior to hiring</li> <li>Ensure Sub-contractors have a copy of the Project ESMP as part of the tender process</li> <li>Ensure sub-contractors attend environmental training / induction session</li> <li>Audit the performance of sub-contractors during the Project</li> <li>Adhere to the local hiring policy (see section below) for prioritising local contractors.</li> <li>Require sub-contractors to provide a copy of their HR policy for approval, or that they commit to following the EPC Contractor's/NEGU's HR policy.</li> </ul>	EPC Contractor	Part of contractor tender process	Proof of checks, training records Site inspection records HR policies approved by EPC Contractor
	Management and site control	<ul style="list-style-type: none"> <li>Nominate person within Contractor's organisation with defined responsibility for EHS role in Project</li> <li>Require all method statements to include EHS requirements</li> <li>Through relevant training, ensure everyone on site is aware of their responsibilities and liabilities with respect to the environment and social responsibility.</li> <li>Through site induction, make staff and visitors aware of Project environmental issues and environmental standards</li> <li>Display warning signs at key work sites prominently</li> <li>Make NEGU's environmental policy available to all on site</li> </ul>	EPC Contractor	Throughout project works	Successful third-party audit (NEGU Environmental Consultant)
		<ul style="list-style-type: none"> <li>Adequately protect primary work sites against vandalism, theft and breakage. Construction works Contractor to be responsible for security the site at all times while the services are being performed</li> <li>Secure the worksite boundary</li> </ul>	EPC Contractor		
All site works	<ul style="list-style-type: none"> <li>Establish a safe working environment with an occupational health and safety (OHS) plan that addresses potential hazards, identifies preventive and</li> </ul>	EPC Contractor	Throughout project works	OHS Plan	

Objective	Activity	Action	Responsibility	Timescales	Monitoring / KPI
		protective measures, including training and use of PPE, and describes documentation and reporting of accidents, diseases and incidents.			
	Liaison with the local community	<ul style="list-style-type: none"> <li>Identify the key local representatives and keep them informed of Project progress</li> <li>Nominate a community point of contact in the Contractor team and Operations team (a CLO)</li> <li>Display contact board at the perimeter of key work sites stating contact details in the event of a complaint or comment.</li> <li>Use this board to display information about project phasing and other relevant matters</li> <li>Implement the requirements of the grievance mechanism and stakeholder engagement plan (SEP)</li> <li>Deal with any complaints that arise quickly and in accordance with the defined complaints procedure</li> <li>Create a log of complaints and ensure they are properly followed up and resolved</li> </ul>	EPC Contractor/CLO	Start of site works – ongoing thereafter	Complaints register Monthly audits Communication records CLO Daily site walk around Grievance logs Grievance logs Number of complaints
Ensure general site housekeeping and environmental protection	Daily and weekly site inspections of permanent work sites	<ul style="list-style-type: none"> <li>Work sites will be subjected to “walk-round” site inspection by the contractors’ EHS management staff on a daily basis</li> </ul>	EPC Contractor (oversight by NEGU)	Throughout project works	Site inspection records Number of complaints Target zero
Safeguard the wellbeing and improve the living standards of those whose livelihoods are involuntarily displaced	Complete implementation of the Livelihood Restoration Plan	<ul style="list-style-type: none"> <li>Make all compensation payments as required in the LRP.</li> <li>Start (and complete if possible) any livelihood restoration activities as required in the LRP</li> </ul>	EPC Contractor (oversight by NEGU)	To be completed prior to construction	Evidence of compensation paid Close out report

Objective	Activity	Action	Responsibility	Timescales	Monitoring / KPI
Protected Priority Biodiversity Features	Complete mitigation obligations	<ul style="list-style-type: none"> <li>● Prepare a Biodiversity Action Plan (BAP, covering all mitigation for SEFG), including full description of off-site SEFG habitat rehabilitation plan, in relation to achieving “net gain” for SEFG (Lot 1 only).</li> <li>● Prepare Biodiversity Management Plan (BMP) setting out strategy for achieving no-net loss for permanent habitat loss along the OHTL route using off-site vegetation restoration/rehabilitation to compensate for all permanent habitat loss generated by the Project, noting that some species defined as PBF and therefore subject to the “no net loss” mitigation standard per EBRD PR6 occur throughout the entire Project area, such as Goitered Gazelle and Russian Tortoise.</li> <li>● Include in BMP a Pre-Construction monitoring and Relocation Procedure for SEFG including:               <ul style="list-style-type: none"> <li>○ requirement to survey population immediately before construction</li> <li>○ Relocating to the nearest habitats prior to works commencing</li> <li>○ Creation of closed zones, at least temporary, for the period of construction where transport, livestock and people should not get into that can be used for the release of the geckos after relocation and if found during the excavation works</li> <li>○ Long-term monitoring of the population after construction</li> </ul> </li> </ul>	EPC Contractor (oversight by NEGU)	To be completed prior to construction	BAP approved BMP approved.



## 6.4 Mitigation and Management Requirements - Construction

Table 11: Mitigation and management requirements – construction

Objective	Project Activity	Action	Responsibility	Timescale	Monitoring / KPI
Minimise dust generation within the direct AOI (200m from the works)	<p>Earthworks, material handling. (C&amp;D) (NB measures to control dust from vehicle activities described under traffic and transportation)</p> <p>Infrequent maintenance activities (O&amp;M).</p>	<ul style="list-style-type: none"> <li>• Locate activities and rock/earth stockpiles away from identified receptors (ROW and road boundary)</li> <li>• Perform concrete batching off-site (where possible) to minimise dust from this activity in the Project AOI.</li> <li>• Demarcate work area and access roads</li> <li>• Cover, seed or fence stockpiles to prevent wind whipping</li> <li>• Keep stockpiles for the shortest possible time</li> <li>• Consider the prevailing wind direction when siting stockpiles to reduce the likelihood of affecting sensitive receptors</li> <li>• No bonfires</li> <li>• Minimise amounts of material handling and avoid double handling</li> <li>• Seal or re-vegetate completed earthworks as soon as reasonably practicable after completion</li> <li>• Ensure all vehicles carrying loose or potentially dusty material are fully sheeted to or from the site.</li> <li>• Cement and other fine powders will be sealed after use or put in bunded containers</li> <li>• Regular (daily) visual monitoring of dust episodes, soiling of</li> </ul>	EPC Contractor (overseen by NEGU Contractor)	Throughout construction phase	<p>Site inspection records</p> <p>Community grievances</p>

Objective	Project Activity	Action	Responsibility	Timescale	Monitoring / KPI
		vegetation, dust resuspension on the roads and dust clouds <ul style="list-style-type: none"> <li>• Re-vegetate areas as soon as possible (refer to the habitat removal and reinstatement plan (HRRP), see section</li> <li>• Provide works with relevant PPE, including dust masks</li> </ul>			
Minimise the impact of fugitive emissions from vehicle exhausts and equipment on receptors along with the direct AOI and the delivery route from the railway station to the "Material and Equipment Laydown Area."	Earthworks, material handling/vehicle movements	<ul style="list-style-type: none"> <li>• Use of modern vehicle/construction fleet meeting national emissions standards and have regular maintenance work following ("O'z DSt 1057:2004 Vehicles. Safety requirements for technical conditions" and "O'z DSt 1058:2004 Vehicles. Technical inspection. Method of control".</li> <li>• Monitor all engines and equipment are turned off when not in use.</li> <li>• Locate machinery and dust causing activities (e.g. access roads, stockpiles) away from nearby sensitive receptors where practicable</li> <li>• Minimise movement of construction traffic around the site (use demarcated routes only)</li> <li>• Record any exceptional incidents that cause dust, either on- or off-site, and the action is taken to resolve the situation in the log book</li> </ul>	EPC Contractor	Throughout construction phase	Site inspection records  Construction reports
Minimise noise emissions in the OHTL AOI	Operation of site equipment and presence of	<ul style="list-style-type: none"> <li>• Construction activities to be limited to daytime working hours (7 am to 6 pm)</li> </ul>	EPC Contractor	Throughout construction phase	Site inspection records

Objective	Project Activity	Action	Responsibility	Timescale	Monitoring / KPI
	workforce at all work fronts	<ul style="list-style-type: none"> <li>• Locate the “Material and Equipment Laydown Area” and the “Accommodation facility” away from any noise sensitive receptors (NSR)</li> <li>• Temporary Plant and equipment camps among the OHTL route to be positioned as far as possible from the sensitive area (200m) (Water pumping station, water points, nomad camps along the OHTL route.</li> <li>• Inform nearby dwellings on the timing and duration of works and when the noisiest stages are likely to occur (ongoing through the process)</li> <li>• Plant and equipment to be examined daily for defect before the start of works, and under no circumstances should defective equipment be used</li> <li>• Acoustic covers on machine engines to remain closed at all times as applicable</li> <li>• Avoid unnecessary revving of engines and equipment to be switched off when not in use</li> <li>• Site operatives to be briefed in keeping noise to a minimum</li> </ul>			Construction reports
	Construction traffic	<ul style="list-style-type: none"> <li>• Construction activities to be limited to daytime working hours (7 am to 6 pm)</li> <li>• Demarcate specific routes from the existing road to the right of way that maintain a buffer of at</li> </ul>	EPC Contractor	Throughout construction phase	Site inspection records  Construction reports

Objective	Project Activity	Action	Responsibility	Timescale	Monitoring / KPI
		<p>least 200m from NSR where possible.</p> <ul style="list-style-type: none"> <li>• Limit vehicle speeds on track to 20km per hour</li> <li>• No traffic should park up on the route between the railway station and the “Material and Equipment Laydown Area.”</li> <li>• All vehicles to evidence regular maintenance schedule following national stator requirements.</li> </ul>			
Minimise impact on water resources	Groundwater	<ul style="list-style-type: none"> <li>• No groundwater abstractions for construction works.</li> <li>• Prohibit any uncontrolled releases of potentially contaminated water to the ground, e.g. concrete wash out, oily wastewater (see actions on spill control below).</li> <li>• Establish a controlled concrete washout area (at Workfront or construction camp)</li> </ul>	EPC Contractor	Throughout construction phase	<p>Site inspection records</p> <p>Construction reports</p>
Sustainable water use	Construction OHTL / substation	<ul style="list-style-type: none"> <li>• Drinking/potable water for drinking and welfare arrangements at the constrain camp and laydown to be sourced from municipal supply</li> <li>• All cement to be delivered to site pre-mixed or pre-cast from third parties with approved water use licences</li> <li>• Do not use water for dampening down roads.</li> <li>• Potable water should be obtained from a sustainable source (and not obtained from the water pumping stations along the route, without prior approval that it will not affect water available to other</li> </ul>	EPC Contractor	Throughout construction phase	<p>Site inspection records</p> <p>Construction reports</p>

Objective	Project Activity	Action	Responsibility	Timescale	Monitoring / KPI
		uses (e.g. herders) (equating to at least 4.4 litres per day per worker).			
Minimise road hazards, congestion and damage to road infrastructure (surfaced roads) and residents along the route (see also CHS below)	OHTL, S/S and access road construction	<ul style="list-style-type: none"> <li>Contractors should use a pre-defined route from the railway station to the “Material and Equipment Laydown Area” (location TBD)</li> <li>Obtain any necessary approvals</li> <li>Confirm no road improvements are required and, where required to ensure they comply with relevant county requirements</li> <li>Develop a traffic management plan that includes:</li> <li>No stopping of Project-related vehicles or abnormal loads is allowed between the railway station and the “Materials and Equipment Laydown Area.”</li> <li>All drivers to undergo a driver induction</li> <li>Signage at start of the road from Sarimay to Kalaata, through the village of Kalaata and Dzhankeldy and at key points along the new access road and near herder camps and watering points.</li> </ul>	EPC Contractor	Throughout construction phase	Approvals Traffic management plan Training logs/ attendance sheets Signage in place
Minimise road hazards, congestion and damage to road infrastructure (unsurfaced roads/construction areas)		<ul style="list-style-type: none"> <li>Ensure drivers are trained to drive heavy goods vehicles (HGVs) on unsurfaced roads (where necessary)</li> <li>Check all drivers have the necessary license for the vehicle they are driving</li> <li>Ensure all vehicles have up to date maintenance records</li> </ul>	EPC Contractor	Throughout construction phase	Training logs/ attendance sheets Maintenance records Meeting minutes/ attendance sheets/

Objective	Project Activity	Action	Responsibility	Timescale	Monitoring / KPI
		<ul style="list-style-type: none"> <li>Minimise transport of workers along the unsurfaced road sections, use pool vehicles where possible.</li> <li>Consider the location for the accommodation camp and the Material and laydown area to minimise additional transportation through local villages and along the unsurfaced road.</li> <li>Notify the local communities on delivery of wide/heavy loads and how it could potentially impact their road use</li> </ul>			disclosure documents for consultations with communities
Minimise traffic-related accidents (surfaced and unsurfaced roads)		<ul style="list-style-type: none"> <li>Minimise pedestrian interaction with construction vehicles</li> <li>Employ safe traffic control measures, including road signs and flag persons, to warn of dangerous conditions along the unsurfaced road to the work fronts.</li> <li>Report all traffic accidents and statistics in weekly EHS reporting (all contractors)</li> <li>All drivers carrying personnel or material along unsurfaced roads must undertake off-road driver training.</li> <li>Provide awareness training to receptors along the unsurfaced road (herders, residents of Kalaata, works at the worker pumping station)</li> </ul>	EPC Contractor	Throughout construction phase	Road signs Flaggers Reporting on traffic accidents/incidents/ near misses Training logs/ attendance sheets
Minimise impact to soils (contamination)		<ul style="list-style-type: none"> <li>Refuelling equipment and vehicles will be carried out in designated areas on the hard standing</li> </ul>	EPC Contractor	Throughout construction phase	Site inspection records

Objective	Project Activity	Action	Responsibility	Timescale	Monitoring / KPI
		<p>ground to prevent seepage of any spillages.</p> <ul style="list-style-type: none"> <li>• Collection systems will be installed in these areas to manage any spills, and fuels will be collected and reused, treated by incineration or removed by a local contractor.</li> <li>• Drip trays must be used when refuelling and servicing vehicles or equipment, where it is not on a hard standing surface</li> <li>• Hazardous material storage will be on hard standing and impervious surface, and the bulk storage facility will be bunded. The Project will restrict storage and handling of hazardous materials and fuels to bunded areas of sufficient capacity to contain a release. Storage containers will be regularly checked and maintained</li> <li>• Implement measures to address Accidental Leaks/Spills of Oil, Fuel, Chemicals, and Wastes during Construction Activities and manage hazardous materials</li> </ul>			<p>Construction reports</p>
<p>Minimise impact to soils (degradation)</p>		<ul style="list-style-type: none"> <li>• Demarcate specific tracks to work fronts and track vehicles to ensure only demarcated routes are used.</li> <li>• Control access to areas along the route that are not required for construction.</li> </ul>	<p>EPC Contractor</p>		<p>Site inspection records</p> <p>Construction reports</p>

Objective	Project Activity	Action	Responsibility	Timescale	Monitoring / KPI
<p>Implement sustainable site clearance and rehabilitation practices to avoid impact on natural habitats (fixed sands) to avoid the “shifting sands” phenomenon.</p>	<p>Site clearance (OHTL, unsurfaced access routes)</p>	<ul style="list-style-type: none"> <li>• Develop a site clearance and rehabilitation plan (SCRП) (only to be implemented after implementing the Flora and Fauna Identification, Rescue and Relocation plan).</li> </ul> <p>SCRП to address the following:</p> <ul style="list-style-type: none"> <li>• Topsoil removal following sustainable land-use practices</li> <li>• Topsoil storage</li> <li>• Rehabilitation of the temporary work area</li> <li>• Monitor soil restoration</li> <li>• Reuse materials on-site wherever possible</li> <li>• No imported soils or aggregates</li> <li>• Regular checks and surveys for AIS every three months</li> <li>• Organic topsoil (superficial layers) will be used for revegetation activities on-site and in the vicinity of the site.</li> </ul>	<p>EPC Contractor</p>	<p>Plan – pre-NTP Construction phase</p>	<p>Site inspection records  Construction reports</p>
<p>Ensure appropriate handling, storage, disposal of solid waste and hazardous waste to minimise impacts to groundwater, land and workers.</p>	<p>OHTL (including access routes), S/S</p>	<p>Prepare site waste management plan (SWMP) (for OHTL and each S/S), including requirements to:</p> <ul style="list-style-type: none"> <li>• Identity and characterise the source of all waste streams (hazardous and non-hazardous) and the proposed final disposal option (Site waste management</li> <li>• identify temporary waste storage and collection points (hazardous and non-hazardous) at the Workfront’s, at Materials Laydown area) for coordinated onward transportation and disposal at a licences facility.</li> </ul>	<p>EPC Contractor</p>	<p>Plan – pre-NTP Construction phase</p>	<p>Site inspection records  Construction reports</p>



Objective	Project Activity	Action	Responsibility	Timescale	Monitoring / KPI
		<ul style="list-style-type: none"> <li>● Identify waste reuse and recycling disposal routes to process waste streams (following Uzbeks requirements).</li> <li>● Identify construction waste landfill</li> <li>● Obtain license and authority of final disposal locations</li> <li>● Identify and contact authorised transportation company to take waste to the disposal facility (in particular hazardous waste)</li> <li>● Define and establish a documentation management system for tracking waste (duty of care)</li> <li>● Maintain a hazardous waste inventory.</li> <li>● Segregate waste material on-site for disposal via the identified channels as per SWMP)</li> <li>● All skips/waste storage to be suitably covered (to avoid dispersion of light materials by wind or filling of skip with rain) and waterproofing to avoid any soil contamination from leachate</li> <li>● Hazardous waste to be designed according to GIP (bundling, separate of incompatible hazardous substations etc.).</li> <li>● Liquid wastes/oil/chemicals to be stored in tanks or drums located in banded areas that can hold 110% of the total storage volume and according to national safety requirements.</li> </ul>			

Objective	Project Activity	Action	Responsibility	Timescale	Monitoring / KPI
		<ul style="list-style-type: none"> <li>Implement good housekeeping and operating practices, including inventory control to reduce the amount of waste resulting from out-of-date materials, off-specification, contaminated, damaged, or excess to plant needs</li> </ul>			
Prevent leaks, spills and environmental incidents	Site establishment & construction	Develop a spills response procedure (may be part of the wider EPRP), including requirements to: <ul style="list-style-type: none"> <li>Maintain an inventory of hazardous materials and specific procedures/ controls</li> <li>Maintain available copies on site of Material Safety Data Sheets (MSDS) for all hazardous substances used during the Project:</li> <li>Establish hazardous materials storage areas that are located away from existing sensitive receptors and are secure from theft or vandalism, well ventilated, have suitable emergency response equipment (fire extinguisher, eye wash etc.) and PPE.</li> <li>Ensure spill kits are located and first response equipment at all work fronts.</li> <li>Ensure no hazardous materials are stored in large quantities at the work fronts but instead at the central Materials store and laydown area</li> </ul>	EPC Contractor	Plan – pre-NTP Construction phase	Site inspection records  Construction reports

Objective	Project Activity	Action	Responsibility	Timescale	Monitoring / KPI
<p>Minimise impact to sensitive habitats and habitat loss in the ROW – General</p>	<p>OHTL and ROW access construction</p>	<p>Develop a Flora and Fauna Identification, Rescue and Relocation plan to include the following species:</p> <ul style="list-style-type: none"> <li>● Reptiles: Southern even fingered gecko, Russian tortoise</li> <li>● Flora: <i>Acanthophyllum cyrtostegium</i>, <i>Tulipa lehmanniana</i></li> <li>● Nesting birds: Macqueen’s Bustard</li> </ul> <p>Other actions include:</p> <ul style="list-style-type: none"> <li>● Demarcate the area to be cleared and minimise land clearance needs as much as possible.</li> <li>● Only clear land in the area where the tower foundations will be located.</li> <li>● Access to the tower foundations must be via the demarcated access road (not along the right of way).</li> <li>● Limit land clearance and occupation to the minimum necessary for the Project works.</li> <li>● No access track along the entire ROW. Use existing road where possible to access the tower work fronts.</li> <li>● Rehabilitate temporarily disturbed areas as soon as possible after construction activity is finished to minimise risk of shifting sands</li> <li>● Minimise use of trenches or other steep-walled excavations</li> <li>● Backfill open excavations as soon as possible after construction activity</li> </ul>	<p>EPC Contractor</p>	<p>Plan – pre-NTP Construction phase</p>	<p>Site inspection records  Construction reports</p>

Objective	Project Activity	Action	Responsibility	Timescale	Monitoring / KPI
		<ul style="list-style-type: none"> <li>Perform terrestrial animal survey and rescue/relocation, immediately prior to construction including Construction phase.</li> <li>Employ bio monitor present on site during excavation works to assure compliance with construction phase mitigation measures, and to conduct daily searches of work fronts and animal rescue from open trenches, as needed.</li> </ul>			
Reptiles	Excavation works	<ul style="list-style-type: none"> <li>Install temporary fencing around takyrs to exclude people, heavy machinery, equipment laydown, or any vehicles from entering/disturbing takyr habitats for protection of SEFG within, and in close proximity to the direct construction area (22 km segment in the eastern portion of Lot 1 only).</li> <li>Worker/contractor training/awareness, supervision regarding impacts to animals and protection of species.</li> <li>Prohibit poaching and interactions with fauna and flora in the worker code of conduct.</li> <li>Establishment, posting, and enforcement of vehicular speed limits, and other traffic management measures.</li> </ul>	EPC Contractor	Plan – pre-NTP Construction phase	Flora and Fauna Identification, Rescue and Relocation plan
Mammals	Excavation works	<ul style="list-style-type: none"> <li>Minimise use of trenches or other steep-walled excavations</li> </ul>	EPC Contractor	Plan – pre-NTP	Survey report

Objective	Project Activity	Action	Responsibility	Timescale	Monitoring / KPI
		<ul style="list-style-type: none"> <li>Do not leave open trenches overnight unless they are fenced.</li> <li>Do not leave open trenches for more than 24 hours once work is complete.</li> <li>Restriction of construction activity to outside of April and May, the key birthing period for Goitered Gazelle (restriction may be refined following spring mammal surveys)</li> <li>Worker/contractor training/awareness, supervision regarding impacts to animals and protection of species.</li> <li>Prohibit poaching and interactions with fauna and flora in the worker code of conduct.</li> <li>Establishment, posting, and enforcement of vehicular speed limits, and other traffic management measures.</li> </ul>		Construction phase	Bio-monitor hired
Flora	Excavation works	<ul style="list-style-type: none"> <li>Preconstruction sensitive plant survey and rescue/relocation (Acanthophyllum cyrtostegium, Tulipa lehmanniana) including construction phase plant rescue/relocation report.</li> </ul>	EPC Contractor	Plan – pre-NTP Construction phase	Survey report
Birds	Excavation works	<ul style="list-style-type: none"> <li>Restriction of construction activity to outside of April and May, in nesting period for Macqueen’s Bustard (applies to eastern third of Lot 1).</li> </ul>	EPC Contractor	Plan – pre-NTP Construction phase	Project schedule

Objective	Project Activity	Action	Responsibility	Timescale	Monitoring / KPI
		<ul style="list-style-type: none"> <li>Prohibit poaching and interactions with fauna and flora in the worker code of conduct</li> <li>Worker/contractor training/awareness, supervision regarding impacts to animals and protection of species.</li> <li>Prohibit poaching and interactions with fauna and flora in the worker code of conduct.</li> </ul>			
Minimise loss of ecosystem services	Construction of OHTL and access roads	<ul style="list-style-type: none"> <li>Implement the LRP to mitigate any impacts on the impacted nomadic herders.</li> </ul>	EPC Contractor	Plan – pre-NTP Construction phase	Site inspection records  Construction reports
Raise worker awareness of the biodiversity risks	Construction of OHTL and access roads	<ul style="list-style-type: none"> <li>Add the following to the Worker Code of Conduct - "Workers are prohibited from:                             <ul style="list-style-type: none"> <li>Removing flora from the work area</li> <li>Hunting any species</li> <li>Interaction with large mammals</li> <li>Penalties for infractions</li> </ul> </li> <li>During the site induction, make workers aware of the following sensitivities:                             <ul style="list-style-type: none"> <li>What to do when encountering any of the following species: SEFG, Russian tortoise, snakes etc.</li> <li>Provide works with a visual reference sheet</li> </ul> </li> </ul>	EPC Contractor	Construction phase	Site inspection records  Construction reports

Objective	Project Activity	Action	Responsibility	Timescale	Monitoring / KPI
Manage potential unexpected discovery of archaeological remains/ artefacts	OHTL foundations work and establishing access roads	<ul style="list-style-type: none"> <li>To nominate a responsible person at each work front as the person responsible for overseeing chance finds</li> <li>Develop and implement a chance finds procedure</li> </ul>	EPC Contractor	Construction phase	Chance finds procedure Toolbox talk logs Chance finds register (if necessary)
Safeguard the wellbeing and improve the living standards of those whose livelihoods are involuntarily displaced	Livelihood restoration	<ul style="list-style-type: none"> <li>Implement livelihood restoration activities (if not already completed prior to construction as per the LRP.</li> </ul>	EPC Contractor	Construction phase	Close out report
Protect worker health and safety		<p>Establish (as part of the Contractor ESMS and HR policy the following):</p> <ul style="list-style-type: none"> <li>Occupational Health and Safety Plan addressing impacts from dust, occupational noise, falls from height, electrocution risks etc.</li> <li>Perform risk assessment for all tasks to be undertaken on site</li> <li>Communicate hazards and risks to all workers during setting to work briefings</li> <li>Mandatory PPE to be provided, including steel toe capped boots, overalls, hard hat, hi-vis vest, safety glasses, hard hat AND ear protection, gloves, dust masks for specific tasks (e.g., welding)</li> <li>Develop a Worker Induction Program</li> <li>Worker Code of Conduct</li> <li>Provide relevant training to all workers</li> </ul>	EPC Contractor	Construction phase	Occupational Health and Safety Plan Risk assessment Worker Code of Conduct Worker Induction Program Training logs/ attendance sheets Audit reports Incident reports

Objective	Project Activity	Action	Responsibility	Timescale	Monitoring / KPI
		<ul style="list-style-type: none"> <li>● Undertake regular inspection and audits and ensure there is a corrective action process</li> <li>● Document and report occupational accidents, diseases and incidents</li> <li>● Locate worker accommodation more than 500m from work fronts.</li> <li>● Implement and communicate emergency prevention, preparedness and response arrangements</li> </ul>			
Protect community health and safety		<ul style="list-style-type: none"> <li>● Develop Worker Code of Conduct to be read and signed by all workers on the contract during the induction process.</li> <li>● Include the worker code of conduct, requirements for addressing potential GBVH risks on the Project and setting out a zero-tolerance policy for the following:               <ul style="list-style-type: none"> <li>○ Use of drugs, alcohol</li> <li>○ Incidents of GBVH</li> </ul> </li> <li>● Ensure security plan includes requirements for vetting security guards, training on the use of force, security guard code of conduct etc.</li> <li>● Establish signs across the Project Site and along roads as required to warn local community members and other external stakeholders of any risks and hazards, e.g., from site vehicles, electrical equipment</li> </ul>	EPC Contractor (overseen by NEGU Contractor)	Construction phase	Worker Code of Conduct Vetting of security guards Training logs/ attendance sheets Signs in place Meeting minutes/ attendance sheets Number of grievances received



Objective	Project Activity	Action	Responsibility	Timescale	Monitoring / KPI
		<ul style="list-style-type: none"> <li>• Establish a Community Grievance Mechanism as set out in the Project SEP (Volume V)</li> <li>• Hold meetings with local herders at the start of works to explain risks and issues</li> <li>• Provide cultural awareness training for all workers.</li> </ul>			
GBVH		<ul style="list-style-type: none"> <li>• Provide training and awareness-raising on GBVH Policy to all employees (including sub-contractor employees).</li> <li>• Nominate dedicated person for receiving GBVH grievances and trained on how to respond to incidents of GBVH nature</li> <li>• Elaborate GBVH referral pathways and mechanisms as part of the external grievance mechanism</li> <li>• Providing safe, secure and separate living spaces and sanitary facilities for the male and female workers lockable sanitary facilities will be mandatory for women</li> <li>• Allow submission and investigation of anonymous sexual harassment complaints by</li> </ul>	EPC Contractor (overseen by NEGU Contractor)	Construction phase	Training logs/ attendance sheets Number of GBVH grievance received

Objective	Project Activity	Action	Responsibility	Timescale	Monitoring / KPI
		<p>workers and host community members and protect the confidentiality of the complainants</p> <ul style="list-style-type: none"> <li>• Work in close coordination with the local authorities in investigating any complaints relating to gender violence and harassment in the host communities where it relates to project workers</li> <li>• Provide targeted training (including in life skills such as leadership and decision-making) and awareness-raising to vulnerable workers such as women</li> </ul>			
Labour wellbeing		<ul style="list-style-type: none"> <li>• Ensure all workers on the Project have a written project contract</li> <li>• Provide an HR onboarding for all workers and explain the contract terms as per EBRD PR2.</li> <li>• Establish a Workforce Grievance Mechanism and ensure confidentiality and anonymity where required.</li> <li>• Ensure appropriate welfare provisions (water, shelter, sanitary facilities, food) at the work fronts</li> <li>• Ensure all workers receive the appropriate training as per the training need analysis and matrix developed under the ESMS (note specific requirements for working within a substation or on live equipment).</li> <li>• Undertake daily toolbox talks at all work fronts</li> </ul>	EPC Contractor	Construction phase	<p>Worker contracts Training logs/ attendance sheets Grievance mechanism Number of grievances received Labour statistics</p>

Objective	Project Activity	Action	Responsibility	Timescale	Monitoring / KPI
		<ul style="list-style-type: none"> <li>• See also requirements under Emergency Preparedness, and Response</li> <li>• Provide all workers with notification of the duration of their contract at the start of works.</li> <li>• Develop labour reporting statistics for all workers, including identifying labour statistics per worker category (local, regional, international) and the split between male and female workers.</li> </ul>			
Emergency preparedness - general		Develop EPRP with the following minimum requirements: <ul style="list-style-type: none"> <li>• Identification of the emergency scenarios.</li> <li>• Specific emergency response for each situation relevant to the Project.</li> <li>• Emergency contacts and communication systems/protocols (including communication with Affected Communities when necessary).</li> <li>• Outline of medical facilities and services required on-site in a Medical Services Procedure and a Casualty Evacuation Procedure.</li> <li>• Assess local emergency services and identify gaps that may need to be filled.</li> <li>• Procedures for interaction with government authorities (emergency, health, environmental authorities),</li> </ul>	EPC Contractor	Construction phase	EPRP Site medical services in place Drill reports

Objective	Project Activity	Action	Responsibility	Timescale	Monitoring / KPI
		<p>including names and contact details.</p> <ul style="list-style-type: none"> <li>● Site plan indicating requirements for permanently stationed emergency equipment and facilities (e.g., first aid stations, firefighting equipment, spill response equipment and personal protective equipment (PPE) for the emergency response teams).</li> <li>● Minimum requirements for trained medical professionals on-site, including first aid stations</li> <li>● Protocols for the use of emergency equipment and facilities.</li> <li>● Clear identification of evacuation routes and Assembly Points (AP) for each work location (including core sites and satellite sites) highlighted on a site plan.</li> <li>● Identification of training requirements for all employees and third-party providers.</li> <li>● Emergency drills and their frequency are based on assigned emergency levels or tiers and an implementation schedule.</li> <li>● Establish a site clinic to provide emergency first aid to employees capable of providing first aid response electrocution, falls from height, etc.</li> <li>● Medical evacuation procedures to the nearest A&amp;E facility.</li> </ul>			

Objective	Project Activity	Action	Responsibility	Timescale	Monitoring / KPI
Emergency preparedness – climate risks/natural hazards		<ul style="list-style-type: none"> <li>Undertake continuous monitoring of weather events to enable an early warning of any high winds, storms, dust storms, extreme precipitation to enable workers to get to shelter</li> <li>Establish worker emergency shelters along the route (Kalaata, Dzhankeldy, Water pumping station etc.)</li> <li>During periods of high wind (15 km/h), any dust-generating activities will not be permitted within 200 m of populated settlements located in the direction of the prevailing wind</li> <li>Provide all workers with dust masks in the event of a localised dust event</li> </ul>	EPC Contractor	Construction phase	Worker emergency shelters
Security	Along OHTL route and at work fronts, Substation and accommodation facility	<ul style="list-style-type: none"> <li>Perform security risk assessments</li> <li>Define in a security management plan the following:</li> <li>Describe the project security approach and systems, e.g., Security Barriers—such as fences, gates, locks, fortifying facilities, and means of access control</li> <li>Accommodation security</li> <li>Requirements for vetting security personnel, security uniform,</li> <li>Undertake training of security guards on human rights and use of force</li> <li>Develop Security Code of Conduct and train security personnel in weapons handling,</li> </ul>	EPC Contractor/ Security contractor	Construction phase	Security risk assessment Security management plan Security Code of Conduct Training logs/ attendance sheets

Objective	Project Activity	Action	Responsibility	Timescale	Monitoring / KPI
Safeguarding community members and workers against communicable diseases (particularly COVID-19)		<p>human rights and receipt of grievance</p> <p>Prepare a COVID-19 site plan, including but not limited to the following requirements:</p> <ul style="list-style-type: none"> <li>● COVID-19 Construction Risk Assessment (including accommodation facility).</li> <li>● Measures for social distancing (during the execution of the works on-site, transportation and within the accommodation camp).</li> <li>● Measures to minimise the risk of contamination of site personnel from outside the project site (and construction camp), particularly local workers not residing in the accommodation camp.</li> <li>● Measure to minimise the risk of transmission to the local community from site personnel.</li> <li>● Requirements for quarantine (or equivalent isolation) for personnel from outside the site (and from abroad). Types of monitoring implemented. Location and control of quarantine if applicable.</li> <li>● Emergency procedure in case of positive cases or outbreak (for affected personnel and potentially affected personnel).</li> <li>● The organisation of meetings on-site.</li> <li>● Training of workers on the main ways COVID-19 can be spread, the known ways to limit the</li> </ul>	EPC Contractor/ Security contractor	Construction phase	<p>COVID-19 Construction Risk Assessment</p> <p>COVID-19 site plan</p> <p>Training logs/ attendance sheets</p>

Objective	Project Activity	Action	Responsibility	Timescale	Monitoring / KPI
		<p>spread and the symptoms of the virus.</p> <ul style="list-style-type: none"> <li>• Control of implementation of COVID-19 measures by subcontractors.</li> <li>• Measures for mitigating the risk of delays from equipment suppliers from countries where COVID-19 outbreaks can occur.</li> <li>• Coordination with local and regional public health officials.</li> <li>• Management of risk of transmission to the local community (especially the management of mixing workers from the community with those housed in workers accommodation).</li> <li>• Provision of PPE to reduce the risk of spreading COVID-19, such as masks and provision of hand sanitizer.</li> </ul>			

## 6.5 Mitigation and Management Requirements – Operation phase

Table 12: Mitigation and management requirements – operation phase

Objective	Activity	Action	Responsibility	Timescales	Evidence
Implement ESMS in line with GIP	O&M works – waste	<ul style="list-style-type: none"> <li>• Ensure ESMS includes relevant requirements for E&amp;S and H&amp;S related training, communication, monitoring, reporting, accident incident reporting, auditing, management review, continuous improvement</li> </ul>	NEFU	Annually	Annual ESMS audit

Objective	Activity	Action	Responsibility	Timescales	Evidence
Operational management planning		<ul style="list-style-type: none"> <li>Develop Project O-ESMP</li> <li>Ensure corporate grievance mechanism is disclosed in project areas</li> <li>All maintenance work to have a specific risk assessment addressing waste, climate risks H&amp;S, hazardous material management, emergency preparedness and response, traffic risks)</li> <li>Implement waste management practices in line with O-ESMP and NEGU ESMS</li> <li>Ensure correct PPE at all times</li> </ul>	NEGU	Annually	Annual reporting
Minimize climate risk to workers performing O&M works.	O&M works	<ul style="list-style-type: none"> <li>Monitor climate risks as part of maintenance works risk assessments</li> </ul>	NEGU	Operations phase - ongoing	Monthly O&M reporting
Ensure rehabilitation of disturbed areas is successful	O&M works	<ul style="list-style-type: none"> <li>Implement the requirement of the biodiversity management plan for habitat restoration for no-net loss.</li> </ul>	NEGU	Operations phase – 5 years or as necessary	Monthly O&M reporting
Biodiversity	O&M works	<ul style="list-style-type: none"> <li>Implement requirements of the Biodiversity Actino Plan (SEFG) for net gain</li> </ul>	NEGU	Operations phase – 5 years or as necessary	Monthly O&M reporting
Ensure livelihoods are not adversely impacted in the long-term	O&M works	<ul style="list-style-type: none"> <li>Monitor impacted households for at least three years to ensure they have at least returned to their previous level of livelihood, if not improved their livelihood.</li> <li>Monitor the implementation of livelihood restoration activities.</li> </ul>	<ul style="list-style-type: none"> <li>NEGU</li> </ul>	Operations phase	Monthly O&M reporting



## 7 Monitoring and reporting

Within the framework of the NEGU or Contractor ESMS as required above, the monitoring and reporting outlined in Table 13 and Table 14 are required as a minimum for the construction and operation respectively.

Table 13: Monitoring and reporting obligations -construction

Monitoring	Parameters	Frequency & Duration	Location	Reporting obligations	Responsibility
<b>OHS and environmental and social statistics (including COVID-19 statistics)</b>	Numbers of fatalities, accidents and injuries. Incident reporting and follow up actions.  Environment: waste, water use	Monthly	Site	Monthly construction monitoring report (see template in Appendix D)	EPC Contractor
<b>Labour and worker grievance statistics</b>	Number of workers, gender of workers and if they are local or not and subcontractor statistics.	Monthly	Site	Monthly construction monitoring report (see reporting templates in Appendix D)	EPC Contractor
<b>Labour accommodation</b>	Compliance of accommodation against the labour accommodation plan	Monthly	Labour accommodation	Monthly construction monitoring report or accommodation audit report (see template in Appendix D)	EPC Contractor
<b>Labour and working conditions</b>	Review of working conditions, paysheets and payslips, leave allocation, and interview with workers to verify findings	Monthly	Site	Monthly construction monitoring report or labour audit report	EPC Contractor
<b>Security incidents</b>	Security incidence. Incident reporting and follow up actions.	Monthly	Site	Monthly construction monitoring report	EPC Contractor
<b>Stakeholder engagement</b>	Stakeholder engagement completed (stakeholder log)	Monthly	Site/local communities	Monthly construction monitoring report	EPC Contractor
<b>Grievances</b>	Number of community grievances received (grievance log). Responses and follow up actions.	Monthly	Site/local communities	Monthly construction monitoring report	EPC Contractor

Table 14: Monitoring and reporting obligations - operation

Monitoring	Parameters	Frequency & Duration	Location	Reporting obligations	Responsibility
<b>OHS</b>	Numbers of fatalities, accidents and injuries. Incident reporting and follow up actions.	Bi-annually	Site	Bi-annual operations monitoring report	NEGU
<b>Labour statistics</b>	Number of workers, gender of workers and if they are local or not.	Bi-annually	Site	Bi-annual operations monitoring report	NEGU
<b>Labour and working conditions</b>	Review of working conditions, paysheets and payslips, leave allocation, and interview with workers to verify findings  Monitor private employment agencies (if used) for recruitment fees and ensure they are paid by employers rather than prospective job applicants	Bi-annually	Site	Bi-annual operations monitoring report or labour audit report	NEGU
<b>Security incidents</b>	Whether or not there have been security incidence. Incident reporting and follow up actions.	Bi-annually	Site	Bi-annual operations monitoring report	NEGU
<b>Stakeholder engagement</b>	Stakeholder engagement completed	Bi-annually	Site/local communities	Bi-annual operations monitoring report	NEGU
<b>Grievances</b>	Number of worker/community grievances received. Responses and follow up actions.	Bi-annually	Site/local communities	Bi-annual operations monitoring report	NEGU
<b>Biodiversity</b>	Monitor restoration of soils disturbed during construction works until fully rehabilitated.	Annually for first five years	Site	Annual operations monitoring report	NEGU
<b>Biodiveristy</b>	Monitor effectiveness of off-site SEFG habitat rehabilitation seasons against NG criteria  Monitor effectiveness of off-site vegetation restoration/rehabilitati on to compensate for permanent habitat	Annual for first 5 years.	Site	Annual CH monitoring report and no net loss report (including NNL calculation)  Annual bird fatality monitoring reports	NEGU

Monitoring	Parameters	Frequency & Duration	Location	Reporting obligations	Responsibility
	loss against NNL criteria  Monitor bird fatalities for the first three years of Project operation with specific field and analytical methodologies applied to correct for well-known biases in carcass searching data, including searcher efficiency (detectability), carcass removal (scavenging), and crippling bias				

A complete and up-to-date file of all relevant sources of information will be maintained by a designated E&S manager for all phases of the project. This file will be readily accessible and include, as a minimum, copies of the following documents:

- Current environmental permits and consents.
- All relevant Mozambique and International regulations, international guidelines and codes of practice.
- Current calibration certificates for all the equipment that requires calibration by an external organisation.
- The latest version of the ESMP.
- Records for environmental monitoring (inspection forms) and audits.
- Record of the construction programme.
- Manufacturers’ operating manuals for all the environmental monitoring equipment.
- Equipment maintenance and repair records.
- Correspondences in relation to environmental matters / permits including internal and external.
- Minutes of relevant meetings.
- Environmental training records (e.g., attendance records for environmental awareness training).

## 8 Stakeholder Engagement

EBRD Performance Requirement 10 (PR10) requires a Project to identify external and internal stakeholders and establish a means of communication with them. All communication, as well as the stakeholders identified, is documented in the Project Stakeholder Engagement Plan (SEP) that is subject to public disclosure.

For the ESIA phase an SEP has been prepared (Volume V) that presents a detailed plan for stakeholder engagement obligation for the pre-construction, construction, operation and decommissioning phases. The Project is required to:

- Inform and consult with local communities and other relevant stakeholder prior to the development of the facility on potential impacts, management measures and potential opportunities.
- Publicise the Project grievance mechanism with local communities.
- Maintain meaningful dialogue through consultations and information disclosure with local communities and other relevant stakeholders
- Develop a communication records procedure that will log key information provided from and to stakeholders.

Responsibility for implementation of the requirements of the SEP will transfer to the winning contractor upon appointment, and be overseen by NEGU or remain with NEGU for the duration of the project supported by the EPC Contractor as necessary. The EPC Contractor or NEGU will appoint a dedicated person to manage the stakeholder relations as defined in the Project SEP and any new obligations as identified post finalisation of the ESIA.

Internal communication between the Project, EPC Contractor and workers must be defined in a Project Internal Communication Plan.

## 9 Grievance mechanism

A preliminary grievance mechanism been prepared and is included in the stakeholder engagement plan (SEP). JE is currently the main point of contact. However, the grievance mechanism will be modified and either NEGU or the EPC Contractor will take over as the point of contact following the completion of the ESIA preparation phase. A template grievance form has been prepared, that enables the registration of any grievances received and includes measures for the provision of a response to the applicant. It is provided in Annex A.

The form contains of three main sections:

- Section I – general information, including the contact details of applicant. If the applicant prefers to submit an anonymous application his/her name and contact details will not be disclosed. Only the person responsible for responding to the grievances will have this information to deliver the response, or the applicant will be advised that in some cases a direct response may not be able to be provided to an anonymous grievance.
- Section II aimed to reflect main message of applicant.
- Section III demonstrates the response provided to applicant and by whom it is delivered.

## Annex A: Project Grievance Form

Ref №		
1	Name (indicate if complainant preferred to be anonymous)	Full name (if applicable): Gender: Age: Address (if applicable): Occupation (if applicable):  I wish my identity not to be disclosed: ____
2	Contact information (Need to specify the way to get back to complainant)	Mob phone: Fax: Email: Other (specify):
3	How compliant/feedback/request was received and by whom	Phone call: Text/WhatsApp applications: Verbal communication: Letter/Email: Receiver's name:
4	Purpose of contact	Make a compliant: Give feedback: Request information: Other (specify):
	Date application was received	Date: Time:
5	Text of applicant's message	
6	Response message (after receipt of application)	Dear _____  We confirm that we have received your application. We would like to inform you that your application is under review. You will receive the Response within two weeks of submission of the application.  We also would like to inform you that you will get a written response to the issues you have raised in your request. We will keep you updated. Thank you for your understanding.

		<i>This message was delivered to the applicant by _____ on _____ at ___ via _____</i>
7	Summary of the Response provided to the applicant	
8	Follow up actions required:	
9	Date the application was closed	Date:

The message was addressed by \_\_\_\_\_

Date/Month/Year \_\_\_\_\_

The response was delivered by \_\_\_\_\_

Date/Month/Year \_\_\_\_\_

Signature and stamp \_\_\_\_\_

## Annex B: Outline for key environmental management plans

Plan	Scope	Content
<b>Occupational health and safety</b>	All health and safety during the project	<ul style="list-style-type: none"> <li>■ Project description.</li> <li>■ Responsibilities of particular personnel.</li> <li>■ Consultation, induction and training.</li> <li>■ Identification of hazards including assessment and control risks (physical, electrical, biological risks)</li> <li>■ Managing subcontractors.</li> <li>■ Managing incidents.</li> <li>■ Monitoring and review of the plan.</li> </ul>
<b>Emergency preparedness and response plan</b>	Dust storms Extreme heat Natural hazards Fire Explosion Spills	<ul style="list-style-type: none"> <li>■ Title</li> <li>■ Details of crisis management team</li> <li>■ List of contacts with external organisations (names), address, telephone numbers) and individual responsibilities for making these contacts</li> <li>■ List of individual responsibilities under the headings</li> <li>■ Preparation in the event of an accident</li> <li>■ Actions during the emergency (for each scenario)</li> <li>■ Actions after the emergency.</li> <li>■ Sources of necessary information and locations of the pollution control facilities</li> <li>■ Accident and incident reporting</li> <li>■ Spill response</li> </ul>
<b>Vegetation clearance and rehabilitation</b>	Active restoration of disturbed habitat following construction phase works	<ul style="list-style-type: none"> <li>■ Introduction</li> <li>■ Statutory requirements</li> <li>■ Existing environment</li> <li>■ Vegetation management objectives for different habitat types</li> <li>■ Vegetation to be retained</li> <li>■ Vegetation clearance</li> <li>■ Protection of PBF and other key habitats/species</li> <li>■ Rehabilitation management (objectives for each vegetation type)</li> <li>■ Rehabilitation methodology</li> <li>■ Supporting actions (invasive species management, topsoil stripping, recovery and stockpiling, erosion and sedimentation control, species selection and seed collection, fire management)</li> <li>■ Completion criteria, remedial actions and rehabilitation monitoring</li> <li>■ Financing and provision</li> <li>■ Training</li> <li>■ Reporting and review</li> </ul>
<b>Site Waste management plan</b>	General and hazardous waste disposal	<ul style="list-style-type: none"> <li>■ Identify who is responsible - different individuals may be responsible during the various stages of the Project i.e., planning, construction and operation of the Plant. These individuals must be identified for each key stage and be aware of their responsibilities. They will be required to hold sufficient authority to ensure compliance with the WMP by other site operatives.</li> </ul>

Plan	Scope	Content
		<ul style="list-style-type: none"> <li>■ Identify the types and quantities of waste - all waste streams that will be produced during construction, operation and decommissioning require to be identified.</li> <li>■ Hazardous Classes – hazardous wastes will be classified according to the requirements of the EU Hazardous Waste Directive classification system.</li> <li>■ Identify waste management options - as described in the construction and operational EMMPs provided in above, a waste hierarchy for on and off-site options needs to be prepared. Where hazardous wastes are being generated, particular attention to the arrangements for identifying and managing such waste will need to be addressed and procedures put in place.</li> <li>■ Identify waste management sites - the location of waste management sites will need to be identified, ideally the most local sites will be used to minimise transportation costs. It is important that legal contracts are in place when using waste disposal contractors and waste disposal contractors comply with the legal responsibilities of the local and national area.</li> <li>■ Training - all staff must be trained to ensure they understand the requirements of the WMP and their responsibilities therein, this includes in-house teams and sub-contractors.</li> <li>■ Plan - using the steps above, establish indicative percentages of the waste quantities to be produced over the life span of the Project.</li> <li>■ Measures - the quantities of wastes produced will be recorded on a monthly basis, and where possible measures taken to re-use, reduce or recycle waste as appropriate; and</li> <li>■ Monitor – throughout the Project life cycle, waste management on site will be monitored, to ensure compliance with the WMP</li> </ul>
<p><b>Cultural heritage plan</b></p>	<p>Pre-clearance surveys and chance finds procedure</p>	<ul style="list-style-type: none"> <li>■ Procedure for undertaking systematic surveys.</li> <li>■ Procedure for dealing with chance finds.</li> <li>■ Method for recording, collecting and mapping using a global positioning system (GPS) any areas of interest.</li> <li>■ Method for pre-clearance surveys including any below ground assessment</li> <li>■ Method for ensuring that the handling and management of the resources will be done according to their tradition, typology and cultural sequence.</li> <li>■ Documentation procedure; and</li> <li>■ Key roles and responsibilities (EDM, Construction Contractors and Ministry).</li> <li>■ <i>Chance finds procedure</i></li> </ul>



## Annex C: Outline for Social management plans

Plan	Scope	Content
Accommodation Management Plan	Construction camp (accommodation facility)	<ul style="list-style-type: none"> <li>▪ Introduction (baseline conditions, profile of workers, accommodation principles)</li> <li>▪ Camp description</li> <li>▪ Legal and policy framework</li> <li>▪ Economic impacts</li> <li>▪ Social impacts</li> <li>▪ Management of worker accommodation (processes and procedures for accommodation, access entity, EPRP, fire, food, recreation, welfare etc.), organisational framework, workplan an schedule)</li> <li>▪ Management of grievances</li> <li>▪ Monitoring and reporting</li> </ul>
Livelihood Restoration Plan (pre-construction)		<ul style="list-style-type: none"> <li>▪ Introduction</li> <li>▪ Overview of land required for the project</li> <li>▪ Policy and Legal Context</li> <li>▪ Impacts of the Project on Livelihoods</li> <li>▪ Livelihoods Restoration (approach, mechanisms, entitlements matrix, assistance for vulnerable people, etc.)</li> <li>▪ Disclosure of information</li> <li>▪ Monitoring, auditing and reporting</li> <li>▪ Grievance mechanism</li> </ul>

## Annex D: Labour reporting templates

- EBRD PR2 Tool 12: Reporting through the contracting chain template for Contractors - Sarimay-Dzhankeldy 500kV Transmission Line: Contractor reporting forms